

# inoLab<sup>®</sup> Multi 9620 IDS

DIGITAL METER FOR IDS SENSORS



a xylem brand

**Copyright**

© 2017 Xylem Analytics Germany GmbH  
Printed in Germany.

## Contents

<b>1</b>	<b>Overview</b>	<b>7</b>
1.1	Multi 9620 IDS	7
1.2	Sensors	7
1.2.1	IDS sensors	7
1.2.2	Wireless operation of IDS sensors	8
1.2.3	IDS adapter for analog sensors	8
1.2.4	Automatic sensor recognition	9
<b>2</b>	<b>Safety</b>	<b>10</b>
2.1	Safety information	10
2.1.1	Safety information in the operating manual	10
2.1.2	Safety signs on the meter	10
2.1.3	Further documents providing safety information	10
2.2	Safe operation	10
2.2.1	Authorized use	10
2.2.2	Requirements for safe operation	11
2.2.3	Unauthorized use	11
<b>3</b>	<b>Commissioning</b>	<b>12</b>
3.1	Scope of delivery	12
3.2	Power supply	12
3.3	Initial commissioning	12
3.3.1	Connecting the power pack	13
<b>4</b>	<b>Operation</b>	<b>14</b>
4.1	General operating principles	14
4.1.1	Keypad	14
4.1.2	Display	15
4.1.3	Status information	15
4.1.4	Connectors	16
4.1.5	Channel display	17
4.1.6	Sensor info.	17
4.1.7	Display of several sensors in the measuring mode	18
4.2	Switching on the meter	19
4.3	Switching off the meter	19
4.4	Login with user name	19
4.5	Navigation	21
4.5.1	Operating modes	21
4.5.2	Measured value display	21
4.5.3	Menus and dialogs	21
4.5.4	Navigation example 1:Setting the language	23

---

4.5.5	Example 2 on navigation: Setting the date and time . . .	25
<b>5</b>	<b>pH value</b> . . . . .	<b>27</b>
5.1	Measuring . . . . .	27
5.1.1	Measuring the pH value . . . . .	27
5.1.2	Measuring the temperature . . . . .	28
5.2	pH calibration . . . . .	29
5.2.1	Why calibrate? . . . . .	29
5.2.2	When do you have to calibrate? . . . . .	29
5.2.3	Carrying out automatic calibration (AutoCal) . . . . .	29
5.2.4	Carrying out a manual calibration (ConCal) . . . . .	32
5.2.5	Calibration points . . . . .	35
5.2.6	Calibration data . . . . .	36
5.2.7	Continuous measurement control (CMC function) . . .	38
5.2.8	QSC function (sensor quality control) . . . . .	40
<b>6</b>	<b>ORP</b> . . . . .	<b>43</b>
6.1	Measuring . . . . .	43
6.1.1	Measuring the ORP . . . . .	43
6.1.2	Measuring the relative ORP . . . . .	44
6.1.3	Measuring the temperature . . . . .	46
6.2	ORP calibration . . . . .	46
<b>7</b>	<b>Ion concentration</b> . . . . .	<b>47</b>
7.1	Measuring . . . . .	47
7.1.1	Measuring the ion concentration . . . . .	47
7.1.2	Measuring the temperature . . . . .	49
7.2	Calibration . . . . .	50
7.2.1	Why calibrate? . . . . .	50
7.2.2	When to calibrate? . . . . .	50
7.2.3	Calibration (ISE Cal) . . . . .	50
7.2.4	Calibration standards . . . . .	53
7.2.5	Calibration data . . . . .	53
7.3	Selecting the measuring method . . . . .	56
7.3.1	<i>Standard addition</i> . . . . .	57
7.3.2	<i>Standard subtraction</i> . . . . .	59
7.3.3	<i>Sample addition</i> . . . . .	62
7.3.4	<i>Sample subtraction</i> . . . . .	64
7.3.5	Standard addition with blank value correction ( <i>Blank value addition</i> ) . . . . .	67
<b>8</b>	<b>Dissolved oxygen</b> . . . . .	<b>70</b>
8.1	Measuring . . . . .	70
8.1.1	Measuring D.O. . . . .	70
8.1.2	Measuring the temperature . . . . .	72
8.2	FDO® Check (checking the FDO 925) . . . . .	73
8.2.1	Why should you check the sensor? . . . . .	73
8.2.2	When should you check the sensor? . . . . .	73
8.2.3	Perform a FDO® Check . . . . .	73
8.2.4	Evaluation . . . . .	74
8.3	Calibration . . . . .	75

8.3.1	Why calibrate? . . . . .	75
8.3.2	When to calibrate? . . . . .	75
8.3.3	Calibration procedures . . . . .	75
8.3.4	Calibration in water vapor-saturated air . . . . .	75
8.3.5	Calibration via a <i>Comparison meas.</i> . . . . .	76
8.3.6	Calibration data . . . . .	77
<b>9</b>	<b>Conductivity . . . . .</b>	<b>80</b>
9.1	Measuring . . . . .	80
9.1.1	Measuring the conductivity . . . . .	80
9.1.2	Measuring the temperature . . . . .	82
9.2	Temperature compensation . . . . .	82
9.3	Calibration . . . . .	82
9.3.1	Why calibrate? . . . . .	82
9.3.2	When to calibrate? . . . . .	83
9.3.3	Determining the cell constant (calibration in control standard) . . . . .	83
9.3.4	Calibration data . . . . .	84
<b>10</b>	<b>Turbidity measurement (VisoTurb® 900-P) . . . . .</b>	<b>86</b>
10.1	Measuring . . . . .	86
10.1.1	Measuring the turbidity . . . . .	86
10.2	Calibration . . . . .	88
10.2.1	Why calibrate? . . . . .	88
10.2.2	When to calibrate? . . . . .	88
10.2.3	Calibration standards . . . . .	88
10.2.4	Carry out calibration . . . . .	89
10.2.5	Calibration data . . . . .	91
<b>11</b>	<b>Settings . . . . .</b>	<b>93</b>
11.1	pH measurement settings . . . . .	93
11.1.1	Settings for pH measurements . . . . .	93
11.1.2	Buffer sets for calibration . . . . .	95
11.1.3	Calibration interval . . . . .	97
11.2	ORP measurement settings . . . . .	98
11.3	ISE measurement settings . . . . .	98
11.4	D.O. measurement settings . . . . .	101
11.4.1	Settings for D.O. measurement . . . . .	101
11.5	Cond measurement settings . . . . .	102
11.5.1	Settings for IDS conductivity sensors . . . . .	102
11.6	Turb measurement settings . . . . .	104
11.6.1	Settings for turbidity sensors . . . . .	104
11.7	Sensor-independent settings . . . . .	105
11.7.1	<i>System</i> . . . . .	105
11.7.2	<i>Data storage</i> . . . . .	107
11.7.3	<i>Automatic Stability control</i> . . . . .	107
11.8	Reset . . . . .	108
11.8.1	Resetting the measurement settings . . . . .	108
11.8.2	Resetting the system settings . . . . .	111

---

<b>12</b>	<b>Data storage</b>	<b>112</b>
12.1	Manual storage	112
12.2	Automatic data storage at intervals	112
12.3	Measurement data storage	115
12.3.1	Editing the measurement data storage.	115
12.3.2	Erasing the measurement data storage	116
12.3.3	Measurement dataset.	116
12.3.4	Memory locations	117
<b>13</b>	<b>Transmitting data</b>	<b>118</b>
13.1	Saving data to a USB memory device	118
13.2	Transmitting data to a USB printer	118
13.3	Transmitting data to a PC	120
13.4	MultiLab Importer.	122
<b>14</b>	<b>Maintenance, cleaning, disposal.</b>	<b>123</b>
14.1	Maintenance	123
14.1.1	General maintenance activities	123
14.1.2	Exchanging the battery.	123
14.2	Cleaning.	124
14.3	Packing	124
14.4	Disposal.	124
<b>15</b>	<b>What to do if....</b>	<b>125</b>
15.1	pH	125
15.2	ISE.	127
15.3	Dissolved oxygen.	128
15.4	Conductivity	128
15.5	Turbidity	129
15.6	General topics	130
<b>16</b>	<b>Technical data.</b>	<b>132</b>
16.1	Measuring ranges, resolution, accuracy	132
16.2	General data	132
<b>17</b>	<b>Firmware update.</b>	<b>136</b>
17.1	Firmware update for the meter Multi 9620 IDS	136
17.2	Firmware-Update for IDS Sensors.	137
<b>18</b>	<b>Glossary</b>	<b>138</b>
<b>19</b>	<b>Index</b>	<b>141</b>

# 1 Overview

## 1.1 Multi 9620 IDS

The Multi 9620 IDS meter enables you to perform measurements (pH, U, ISE, conductivity, and dissolved oxygen, Turbidity) quickly and reliably.

The Multi 9620 IDS provides the maximum degree of operating comfort, reliability and measuring certainty for all applications.

The Multi 9620 IDS supports you in your work with the following functions:

- proven calibration procedures
- automatic stability control (AR)
- automatic sensor recognition
- CMC (continuous measurement control)
- QSC (sensor quality control).

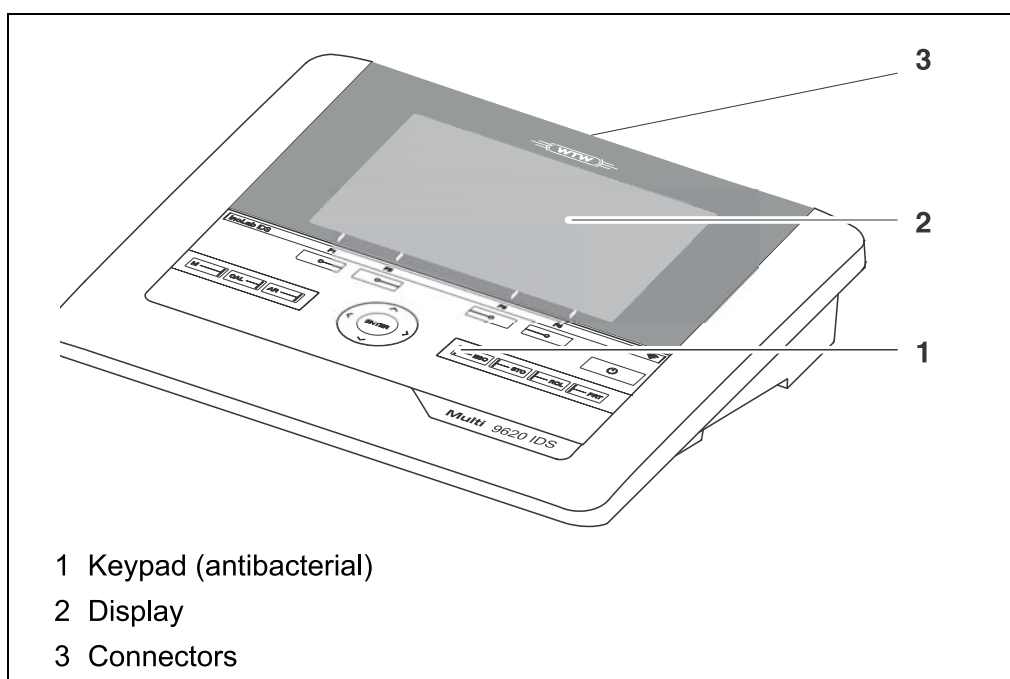

Due to its antibacterial properties, the keypad of the Multi 9620 IDS is especially suitable for applications in an environment where hygiene is important (see SECTION 16.2 GENERAL DATA, page 132).

## 1.2 Sensors

### 1.2.1 IDS sensors

IDS sensors

- support the automatic sensor recognition
- show only the settings relevant to the specific sensor in the setting menu
- process signals in the sensor digitally so that precise and interference-free measurements are enabled even with long cables

- facilitate to assign a sensor to a measured parameter with differently colored couplings
- have quick-lock couplings with which to fix the sensors to the meter.



Information on available IDS sensors is given on the Internet.

### Sensor data from IDS sensors

IDS sensors transmit the following sensor data to the meter:

- SENSOR ID
  - Sensor name
  - Sensor serial number
- Calibration data
- Measurement settings

The calibration data are updated in the IDS sensor after each calibration procedure. A message is displayed while the data are being updated in the sensor.



In the measured value display, you can display the sensor name and serial number of the selected sensor with the [Info] softkey. You can then display further sensor data stored in the sensor with the [More] softkey (see section 4.1.6 SENSOR INFO, page 17).

### 1.2.2 Wireless operation of IDS sensors

With the aid of the adapters in the IDS WLM System, IDS sensors with plug head connectors (variant W) can be wirelessly connected to your Multi 9620 IDS.

Two adapters, one at the IDS meter (IDS WA-M) and one at the sensor (IDS WA-S), replace the sensor cable with an energy-saving Bluetooth LE radio connection.



Further information on the wireless operation of IDS sensors:

- Web resources
- Operating manual of the IDS WLM System.

### 1.2.3 IDS adapter for analog sensors

With the aid of an IDS adapter, you can also operate analog sensors on the Multi 9620 IDS. The combination of the IDS adapter and analog sensor behaves like an IDS sensor.

The following IDS adapters can be operated on the Multi 9620 IDS:



ADA 96/IDS DIN / BNC (pH / U / ISE)	ADA S7/IDS (pH / U)
<p>The socket field of the Multi 9620 IDS has a recess where the IDS adapter (ADA 96/IDS DIN or ADA 96/IDS BNC), which is available as an accessory, can be permanently mounted.</p> <p>In the socket field of the Multi 9620 IDS, the IDS adapter replaces a digital input (channel 2) with a socket field for an analog pH/U/ISE sensor (DIN or BNC plug) and a temperature sensor.</p>	<p>The IDS adapter enables to operate an analog sensor with S7 plug-in connector on any digital input.</p> <p>Temperature measurement with an analog temperature sensor is not possible.</p>



Information on available IDS adapters is given on the Internet. Detailed information on the IDS adapter is given in the operating manual of the adapter.

#### 1.2.4 Automatic sensor recognition

The automatic sensor recognition for IDS sensors allows

- to operate an IDS sensor with different meters without recalibrating
- to operate different IDS sensors at one meter without recalibration
- to assign measurement data to an IDS sensor
  - Measurement datasets are always stored and output with the sensor name and sensor serial number.
- to assign calibration data to an IDS sensor
  - Calibration data and calibration history are always stored and output with the sensor name and sensor serial number.
- to activate the correct cell constant for conductivity sensors automatically
- to hide menus automatically that do not concern this sensor

To be able to use the automatic sensor recognition, a meter that supports the automatic sensor recognition (e.g. Multi 9620 IDS) and a digital IDS sensor are required.

In digital IDS sensors, sensor data are stored that clearly identify the sensor. The sensor data are automatically taken over by the meter.

## 2 Safety

### 2.1 Safety information

#### 2.1.1 Safety information in the operating manual

This operating manual provides important information on the safe operation of the meter. Read this operating manual thoroughly and make yourself familiar with the meter before putting it into operation or working with it. The operating manual must be kept in the vicinity of the meter so you can always find the information you need.

Important safety instructions are highlighted in this operating manual. They are indicated by the warning symbol (triangle) in the left column. The signal word (e.g. "CAUTION") indicates the level of danger:



#### **WARNING**

indicates a possibly dangerous situation that can lead to serious (irreversible) injury or death if the safety instruction is not followed.



#### **CAUTION**

indicates a possibly dangerous situation that can lead to slight (reversible) injury if the safety instruction is not followed.

#### **NOTE**

indicates a possibly dangerous situation where goods might be damaged if the actions mentioned are not taken.

#### 2.1.2 Safety signs on the meter

Note all labels, information signs and safety symbols on the meter. A warning symbol (triangle) without text refers to safety information in this operating manual.

#### 2.1.3 Further documents providing safety information

The following documents provide additional information, which you should observe for your safety when working with the measuring system:

- Operating manuals of sensors and other accessories
- Safety datasheets of calibration or maintenance accessories (such as buffer solutions, electrolyte solutions, etc.)

### 2.2 Safe operation

#### 2.2.1 Authorized use

The authorized use of the meter consists exclusively of the measurement of the pH, ORP, conductivity and dissolved oxygen in a laboratory environment.

Only the operation and running of the meter according to the instructions and technical specifications given in this operating manual is authorized (see section 16 TECHNICAL DATA, page 132).

Any other use is considered unauthorized.

### **2.2.2 Requirements for safe operation**

Note the following points for safe operation:

- The meter may only be operated according to the authorized use specified above.
- The meter may only be supplied with power by the energy sources mentioned in this operating manual.
- The meter may only be operated under the environmental conditions mentioned in this operating manual.
- The meter may not be opened.

### **2.2.3 Unauthorized use**

The meter must not be put into operation if:

- it is visibly damaged (e.g. after being transported)
- it was stored under adverse conditions for a lengthy period of time (storing conditions, see section 16 TECHNICAL DATA, page 132).

## 3 Commissioning

### 3.1 Scope of delivery

- MeterMulti 9620 IDS
- USB cable (A plug on mini B plug)
- Power pack
- Stand with stand base
- Short instructions
- Comprehensive operating manual (4 languages)
- CD-ROM

### 3.2 Power supply

The Multi 9620 IDS is supplied with power in the following ways:

- Mains operation with the supplied power pack
- In the case of power failure:  
The system clock is operated via a buffer battery (see section 14.1.2 EXCHANGING THE BATTERY, page 123).

### 3.3 Initial commissioning

Perform the following activities:

- Connect the power pack  
(see section 3.3.1 CONNECTING THE POWER PACK, page 13)
- Switch on the meter (see section 4.2 SWITCHING ON THE METER, page 19)
- Set the date and time (see section 4.5.5 EXAMPLE 2 ON NAVIGATION: SETTING THE DATE AND TIME, page 25)
- Mount the stand  
(see operating manual of the stand)

### 3.3.1 Connecting the power pack

**CAUTION**

The line voltage at the operating site must lie within the input voltage range of the original power pack (see section 16.2 GENERAL DATA, page 132).

**CAUTION**

Use original power packs only (see section 16.2 GENERAL DATA, page 132).

1. Connect the plug of the power pack to the socket for the power pack on the Multi 9620 IDS.
2. Connect the original power pack to an easily accessible power outlet. The meter performs a self-test.

## 4 Operation

### 4.1 General operating principles

#### 4.1.1 Keypad

In this operating manual, keys are indicated by brackets <.> .

The key symbol (e.g. <ENTER>) generally indicates a short keystroke (press and release) in this operating manual. A long keystroke (press and keep depressed for approx. 2 sec) is indicated by the underscore behind the key symbol (e.g. <ENTER\_>).

<F1> <F4>	Softkeys providing situation dependent functions, e.g.: <F1>/[Info]: View information on a sensor
<On/Off> <On/Off_>	Switches the meter on or off (  )
<M>	Selects the measured parameter
<CAL> <CAL_>	Calls up the calibration procedure Displays the calibration data
<AR>	Freezes the measured value (HOLD function) Switches the AutoRead measurement on or off
<ESC>	Switches back to the higher menu level / Cancels inputs
<STO> <STO_>	Saves a measured value manually Opens the menu for the automatic save function
<RCL> <RCL_>	Displays the manually stored measured values Displays the automatically stored measured values
<▲><▼> <◀><▶>	Menu control, navigation
<ENTER> <ENTER_>	Opens the menu for measurement settings / Confirms entries Opens the menu for system settings
<PRT> <PRT_>	Outputs stored data to the interface Outputs displayed data to the interface at intervals



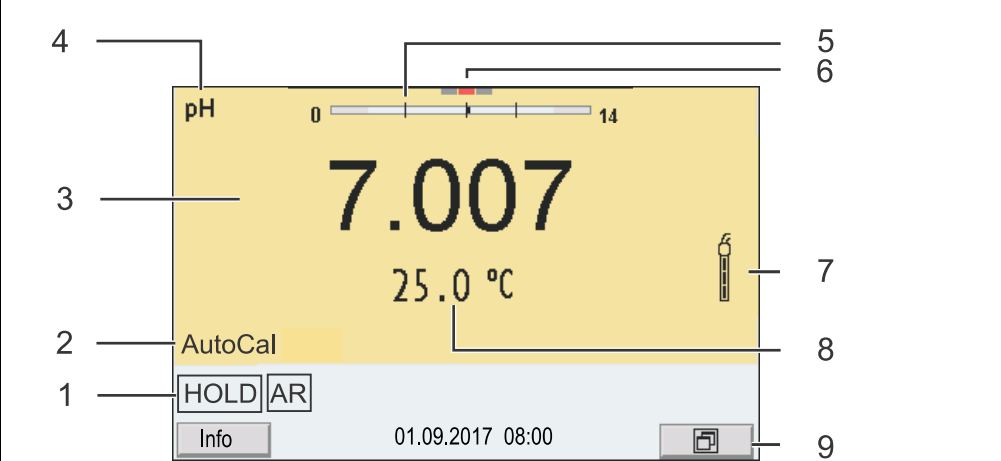

### 4.1.2 Display

Example (pH):



- 1 Status information (meter)
- 2 Status information (sensor)
- 3 Measured value
- 4 Measured parameter
- 5 Continuous measurement control (CMC function)
- 6 Channel display: Plug position of the sensor
- 7 Sensor symbol (calibration evaluation, calibration interval)
- 8 Measured temperature (with unit)
- 9 Softkeys and date + time

### 4.1.3 Status information

AutoCal e.g. TEC	Calibration with automatic buffer recognition, e.g. with the buffer set: Technical buffers
ConCal	Calibration with any buffers
Error	An error occurred during calibration
AR	Stability control (AutoRead) is active
HOLD	Measured value is frozen (<AR> key)
	Data are automatically output to the USB-B interface ( <i>USB Device</i> , e.g. PC) at intervals
	Data are output to the USB-A interface ( <i>USB Host</i> , e.g. USB flash drive)
	Data are output to the USB-A interface ( <i>USB Host</i> , e.g. USB printer). If there is a connection via the USB-B interface at the same time (e.g. to a PC), the data are output to the USB-B interface only.
	Connection to a PC is active (USB-B interface)



Data transmission from / to an IDS sensor is active

#### 4.1.4 Connectors

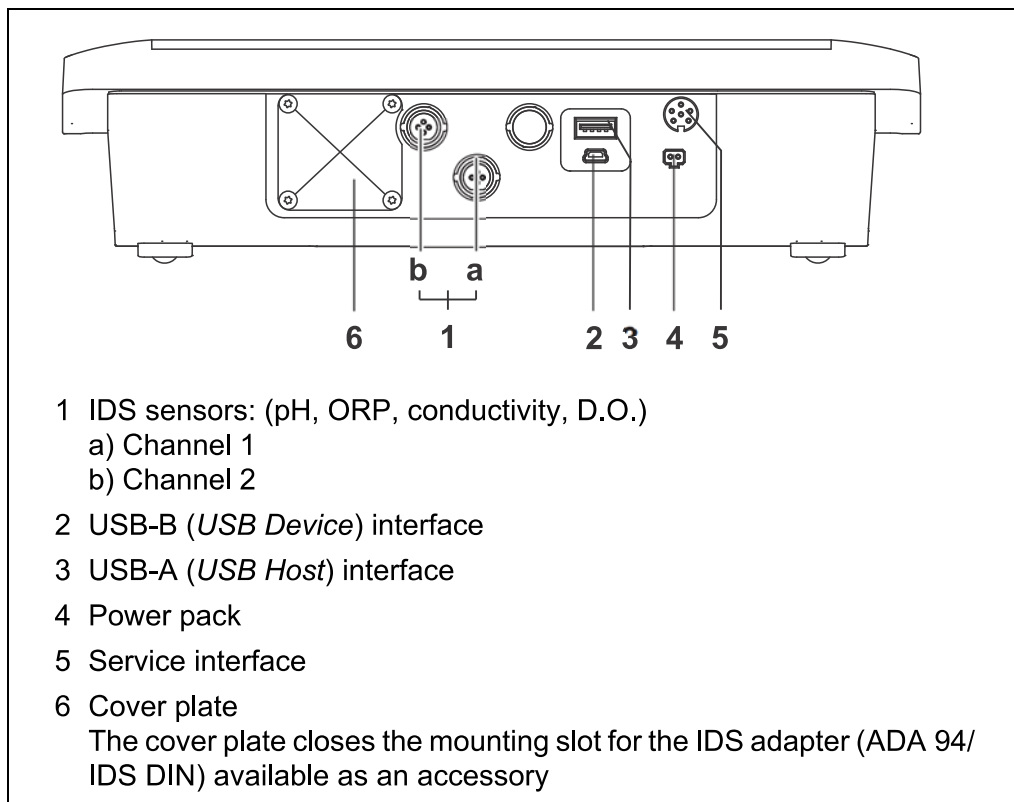

#### CAUTION

Only connect sensors to the meter that cannot return any voltages or currents that are not allowed (> SELV and > current circuit with current limiting).

**WTW IDS sensors and IDS adapters meet these requirements.**



### 4.1.5 Channel display

The Multi 9620 IDS manages the connected sensors and displays which sensor is plugged to which connection.

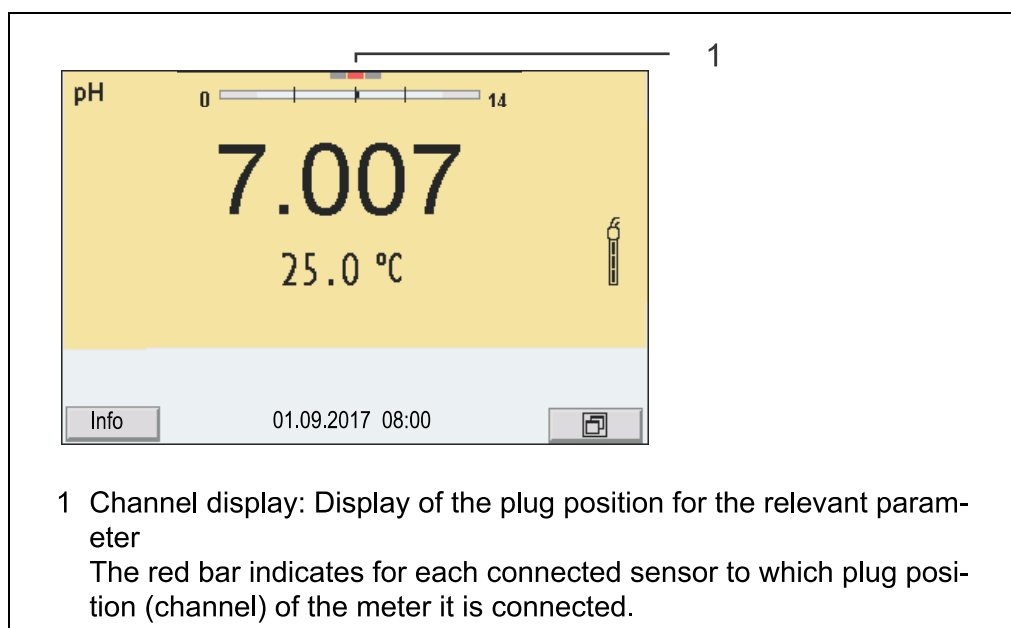

### 4.1.6 Sensor info

You can display the current sensor data and sensor settings of a connected sensor at any time. The sensor data are available in the measured value display with the *[Info]* softkey.

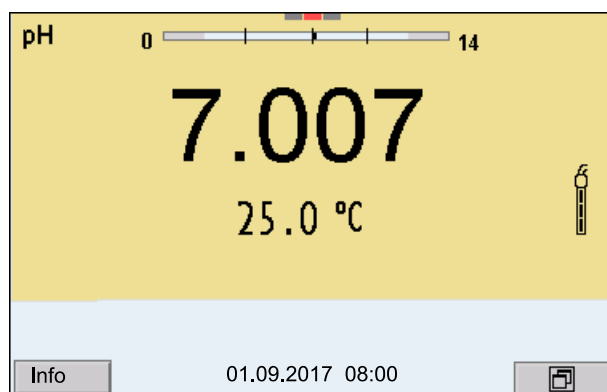

1. In the measured value display:  
Display the sensor data (sensor name, serial number) with *[Info]*.

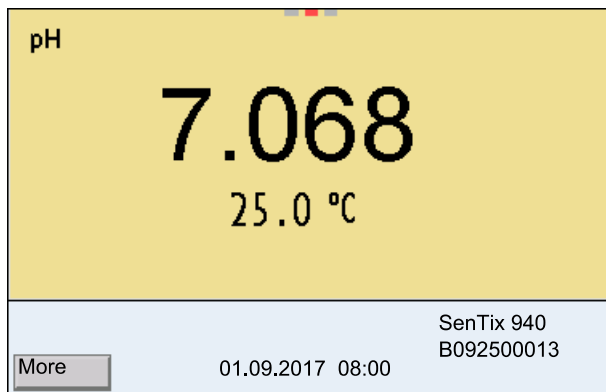

2. Display further sensor data (settings) with [More].

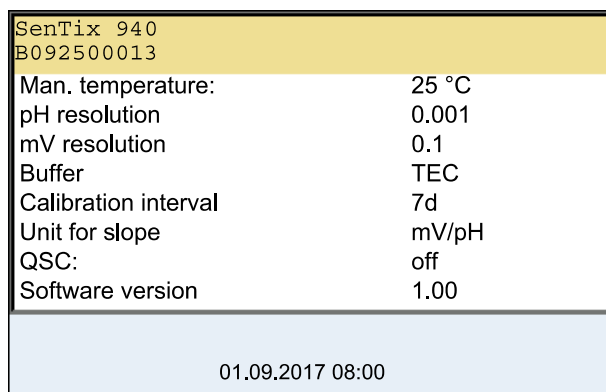

#### 4.1.7 Display of several sensors in the measuring mode

The measured values of the connected sensors can be displayed in the following ways:

- Clear display of all connected sensors
- Detailed display of one sensor (e.g. incl. CMC feature with pH sensors)

With the softkey you can very easily switch between the two display types. The suitable softkey is displayed depending on the operating situation.

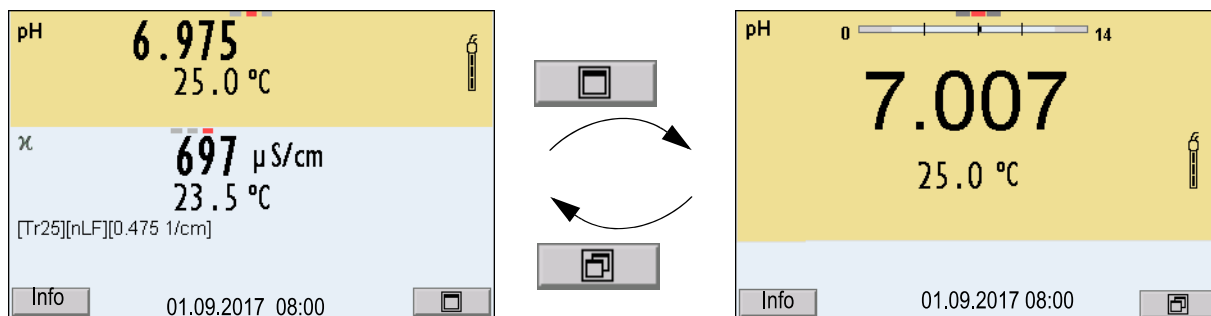

## 4.2 Switching on the meter

1. Switch the meter on with **<On/Off>**.  
The meter performs a self-test.
2. Connect the sensor.  
The meter is ready to measure.



If the user administration function is activated, the *Login* dialog appears after the meter is switched on (see section 4.4 LOGIN WITH USER NAME, page 19).

The user administration function is not active in the delivery condition.

The user administration is activated by the administrator via the PC software *MultiLab User* (see *MultiLab User* operating manual).

## 4.3 Switching off the meter

1. Switch the printer off with **<On/Off>**.

## 4.4 Login with user name

After activation of the user administration by the administrator (see operating manual *MultiLab User*), measurements are only possible after login with a user name. The user name is documented with the measured values and in records.

All user names entered by the administrator are listed in the *User name* menu. The administrator determines for each user whether or not a password is required for the login to the meter.

If the *Password* menu item is grayed out, no password is required for the login.

1. Switch the meter on with **<On/Off>** (or **<On/Off\_>**).  
The *Login* dialog appears.

2. Using **<▲><▼>**, select the menu item, *User name* and confirm with **<ENTER>**.  
The user name is highlighted.
3. Using **<▲><▼>**, select a user name and confirm with **<ENTER>**.



The login is done immediately if no password is required.  
If a sensor is connected the measured value display appears.

4. If a password is required:  
Using **<▲><▼>**, select the menu item, *Password* and confirm with **<ENTER>**.



The user specifies the password when he or she first logs in with a user name.  
A valid password consists of 4 digits.  
The user can change the password with the next login.

5. Change the digit of the highlighted position with **<▲><▼>**.  
Switch to the next position of the password with **<◀><▶>**.  
When the password was completely entered, confirm with **<ENTER>**.  
The login takes place. If a sensor is connected the measured value display appears.

### Changing the password

If the administrator has set up the access with password protection:

1. Switch the meter on with **<On/Off>** (or **<On/Off\_>**).  
The *Login* dialog appears.
2. Using **<▲><▼>**, select the menu item, *User name* and confirm with **<ENTER>**.  
The user name is highlighted.
3. Using **<▲><▼>**, select a user name and confirm with **<ENTER>**.
4. Using **<▲><▼>**, select the menu item, *Change password* and confirm with **<ENTER>**.

5. In the *Password* field, enter the old password with <▲><▼> and <◀><▶> and confirm it with <ENTER>.
6. In the *New password* field, enter the new password with <▲><▼> and <◀><▶> and confirm it with <ENTER>.  
The password is changed.  
The login takes place. If a sensor is connected the measured value display appears.

### Forgotten the password?

Contact the administrator.

## 4.5 Navigation

### 4.5.1 Operating modes

Operating mode	Explanation
<b>Measuring</b>	The measurement data of the connected sensor are shown in the measured value display
<b>Calibration</b>	The course of a calibration with calibration information, functions and settings is displayed
<b>Storing in memory</b>	The meter stores measuring data automatically or manually
<b>Transmitting data</b>	The meter transmits measuring data and calibration records to a USB interface automatically or manually.
<b>Setting</b>	The system menu or a sensor menu with submenus, settings and functions is displayed

### 4.5.2 Measured value display

In the measured value display, you can

- use <▲><▼> to select one of several connected sensors. The selected sensor is displayed with a colored background.  
The following actions / menus refer to the selected sensor
- open the menu for calibration and measurement settings with <ENTER> (short keystroke)
- open the system menu with the sensor-independent settings by pressing <ENTER><Storage & config> for a <ENTER><long> keystroke, approx. 2 s).
- change the display in the selected measuring screen (e. g. pH ↔ mV) by pressing <M>.

### 4.5.3 Menus and dialogs

The menus for settings and dialogs in procedures contain further subelements.

The selection is done with the <▲><▼> keys. The current selection is displayed with a frame.

- Submenus

The name of the submenu is displayed at the upper edge of the frame. Submenus are opened by confirming with <ENTER>. Example:

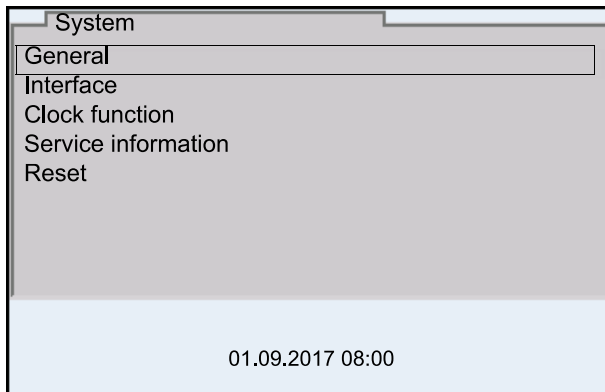

- Settings

Settings are indicated by a colon. The current setting is displayed on the right-hand side. The setting mode is opened with <ENTER>. Subsequently, the setting can be changed with <▲><▼> and <ENTER>. Example:

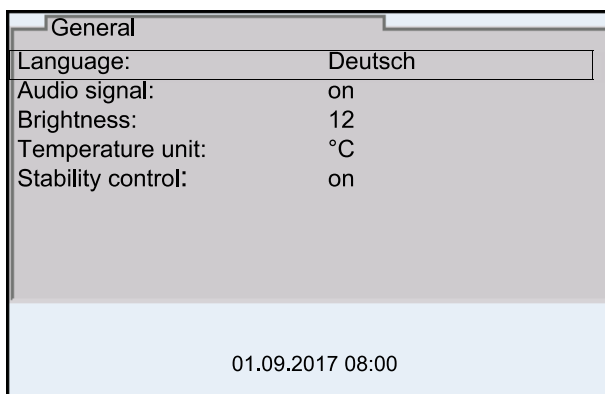

- Functions

Functions are designated by the name of the function. They are immediately carried out by confirming with <ENTER>. Example: Display the *Calibration record* function.

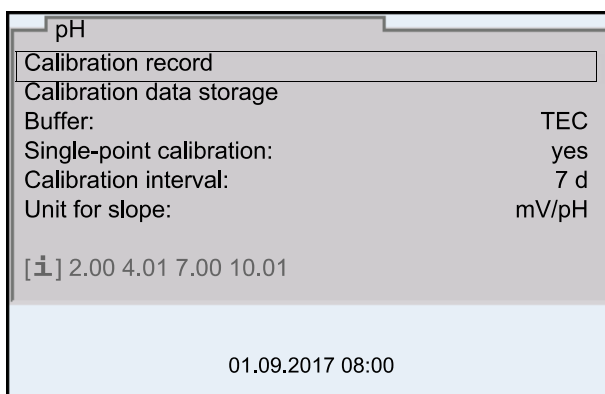

- Messages

Information is marked by the [i] symbol. It cannot be selected. Example:

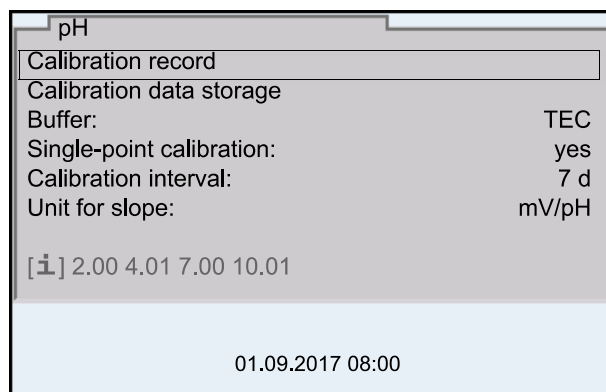

#### 4.5.4 Navigation example 1: Setting the language

1. Press the **<On/Off>** key.  
The measured value display appears.  
The instrument is in the measuring mode.

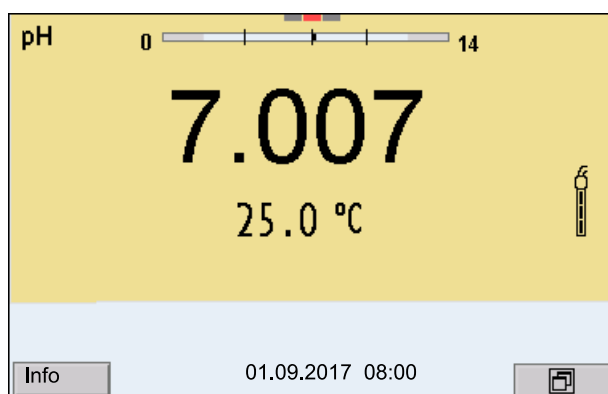

2. Open the *Storage & config* menu with **<ENTER\_>**.  
The instrument is in the setting mode.

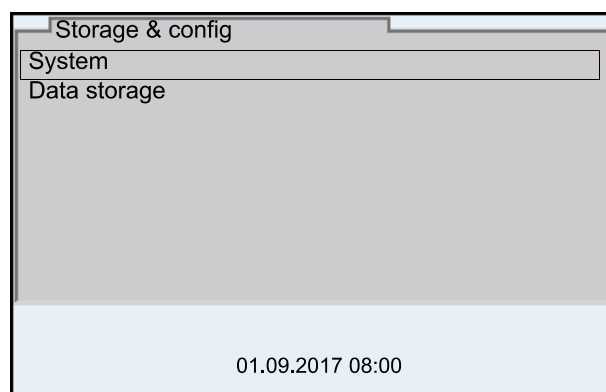

3. Select the *System* submenu with <▲><▼>. The current selection is displayed with a frame.
4. Open the *System* submenu with <ENTER>.

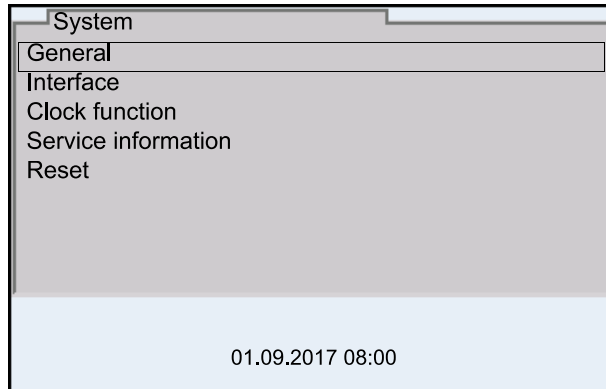

5. Select the *General* submenu with <▲><▼>. The current selection is displayed with a frame.
6. Open the *General* submenu with <ENTER>.

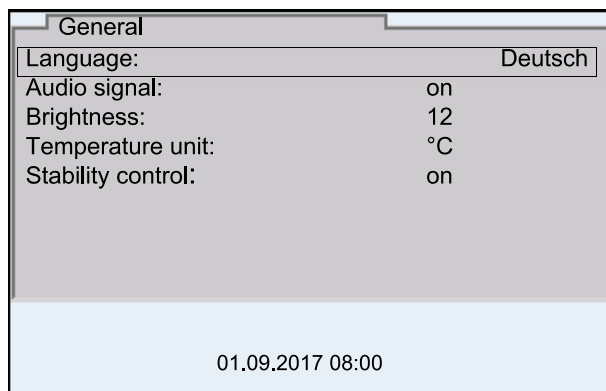

7. Open the setting mode for the *Language* with <ENTER>.

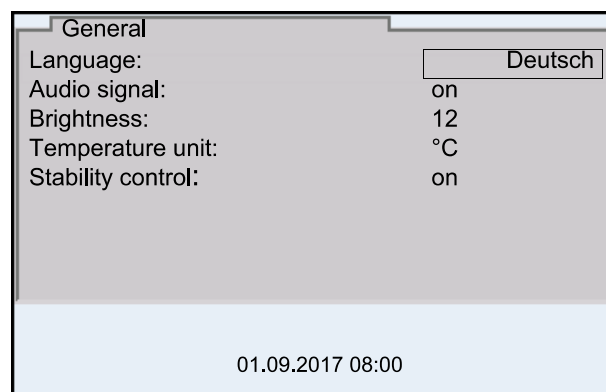

8. Select the required language with <▲><▼>.



9. Confirm the setting with **<ENTER>**.  
The meter switches to the measuring mode.  
The selected language is active.

#### 4.5.5 Example 2 on navigation: Setting the date and time

The meter has a clock with a date function. The date and time are indicated in the status line of the measured value display.

When storing measured values and calibrating, the current date and time are automatically stored as well.

The correct setting of the date and time and date format is important for the following functions and displays:

- Current date and time
- Calibration date
- Identification of stored measured values.

Therefore, check the time at regular intervals.



The date and time are reset if the following conditions are met:

- the supply voltage failed and
- the buffer batteries for the system clock are empty.

#### Setting the date, time and date format

The date format can be switched from the display of day, month, year (*dd.mm.yy*) to the display of month, day, year (*mm/dd/yy* or *mm.dd.yy*).

1. In the measured value display:  
Open the *Storage & config* menu with **<ENTER\_>**.  
The instrument is in the setting mode.
2. Select and confirm the *System / Clock function* menu with **<▲><▼>** and **<ENTER>**.  
The setting menu for the date and time opens up.

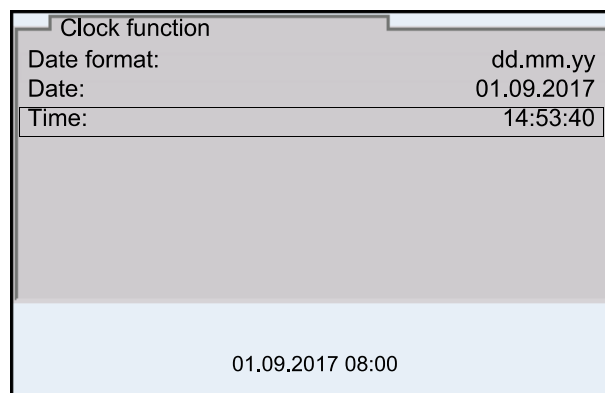

3. Select and confirm the *Time* menu with **<▲><▼>** and **<ENTER>**.  
The hours are highlighted.
4. Change and confirm the setting with **<▲><▼>** and **<ENTER>**.  
The minutes are highlighted.

5. Change and confirm the setting with <▲><▼> and <ENTER>. The seconds are highlighted.
6. Change and confirm the setting with <▲><▼> and <ENTER>. The time is set.
7. If necessary, set the *Date* and *Date format*. The setting is made similarly to that of the time.
8. To make further settings, switch to the next higher menu level with <ESC>. or Switch to the measured value display with <M>. The instrument is in the measuring mode.

## 5 pH value

### 5.1 Measuring

#### 5.1.1 Measuring the pH value



The sensor connection and the USB-B (*USB Device*) interface are galvanically insulated. This facilitates interference-free measurements also in the following cases:

- Measurement in grounded test samples
- Measurement with several sensors connected to one Multi 9620 IDS in one test sample

1. Connect the IDS pH sensor to the meter. The pH measuring window is displayed.
2. If necessary, select the measured parameter with **<M>**.
3. Adjust the temperature of the solutions and measure the current temperature if the measurement is made without a temperature sensor.
4. If necessary, calibrate or check the IDS pH sensor.
5. Immerse the IDS pH sensor in the test sample.

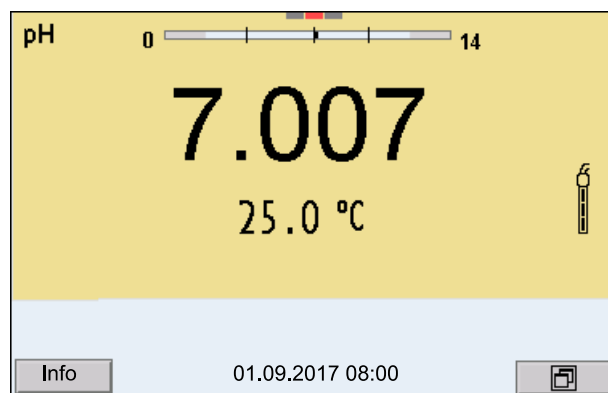

#### Stability control (AutoRead) & HOLD function

The stability control function (*AutoRead*) continually checks the stability of the measurement signal. The stability has a considerable impact on the reproducibility of measured values.

The measured parameter flashes on the display

- as soon as the measured value is outside the stability range
- when the automatic *Stability control* is switched off.

You can start the *Stability control* manually at any time, irrespective of the setting for automatic *Stability control* (see section 11.7.3 AUTOMATIC STABILITY CONTROL, page 107) in the *System* menu.

1. Freeze the measured value with **<AR>**. The [HOLD] status indicator is displayed. The HOLD function is active.



You can terminate the *Stability control* function and the HOLD function with **<AR>** or **<M>** at any time.

2. Using **<ENTER>**, activate the *Stability control* function manually. The [AR] status indicator appears while the measured value is assessed as not stable. A progress bar is displayed and the display of the measured parameter flashes. As soon as a measured value meets the stability criteria, it is frozen. The [HOLD][AR] status indicator is displayed, the progress bar disappears and the display of the measured parameter stops flashing. The current measurement data is output to the interface. Measurement data meeting the stability control criterion is marked by AR.



You can prematurely terminate the *Stability control* function manually with **<ENTER>** at any time. If the *Stability control* function is prematurely terminated, the current measurement data are output to the USB-B (*USB Device*, e.g. PC) or USB-A (*USB Host*, e.g. USB memory device or USB printer) interface without AutoRead info.

3. Using **<ENTER>**, start a further measurement with stability control.  
or  
Release the frozen measured value again with **<AR>** or **<M>**. The [AR] status display disappears. The display switches back to the previous indication.

### Criteria for a stable measured value

The *Stability control* function checks whether the measured values are stable within the monitored time interval.

Measured parameter	Time interval	Stability in the time interval
pH value	15 seconds	$\Delta$ : better than 0.01 pH
Temperature	15 seconds	$\Delta$ : better than 0.5 °C

The minimum duration until a measured value is assessed as stable is the monitored time interval. The actual duration is mostly longer.

### 5.1.2 Measuring the temperature

For reproducible pH measurements, it is essential to measure the temperature of the test sample.

IDS sensors measure the temperature with a temperature sensor integrated in the IDS sensor.

When operating a sensor without integrated temperature sensor, e.g. via an IDS pH adapter, you have to measure and enter the temperature of the test sample first.

The display of the temperature indicates the active temperature measuring mode:

Temperature sensor	Resolution of the temp. display	Temp. measurement
yes	0.1 °C	Automatic with temperature sensor
-	1 °C	Manual

## 5.2 pH calibration

### 5.2.1 Why calibrate?

pH electrodes age. This changes the zero point (asymmetry) and slope of the pH electrode. As a result, an inexact measured value is displayed. Calibration determines and stores the current values of the zero point and slope of the electrode.

Thus, you should calibrate at regular intervals.

### 5.2.2 When do you have to calibrate?

- Routinely within the framework of the company quality assurance
- When the calibration interval has expired

### 5.2.3 Carrying out automatic calibration (AutoCal)

Make sure that in the sensor menu, *Buffer* menu, the buffer set is correctly selected (see section 11.1.1 SETTINGS FOR PH MEASUREMENTS, page 93).

Use one to five buffer solutions of the selected buffer set in any order.

Below, calibration with TechnicalWTW buffers (*TECWTW*) is described. When other buffer sets are used, other nominal buffer values are displayed. Apart from that, the procedure is identical.



If single-point calibration was set in the menu, the calibration procedure is automatically finished with the measurement of buffer solution 1 and the calibration record is displayed.

1. Connect the pH sensor to the meter.  
The pH measuring window is displayed.
2. Keep the buffer solutions ready.  
When measuring without temperature sensor:  
Temper the buffer solutions or measure the current temperature.
3. Start the calibration with **<CAL>**.  
The calibration display for the first buffer appears (voltage display).

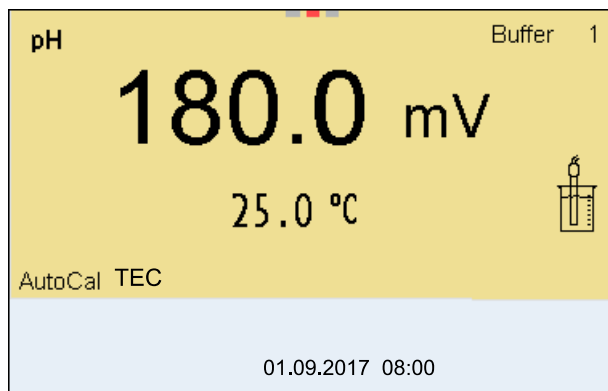

4. Thoroughly rinse the sensor with deionized water.
5. Immerse the sensor in the first buffer solution.
6. For measurements without temperature sensor (e.g. when using an IDS adapter):  
Enter the temperature of the buffer with <▲><▼>.
7. Start the measurement with <ENTER>.  
The measured value is checked for stability (stability control).  
The [AR] status indicator is displayed. The measured parameter flashes.

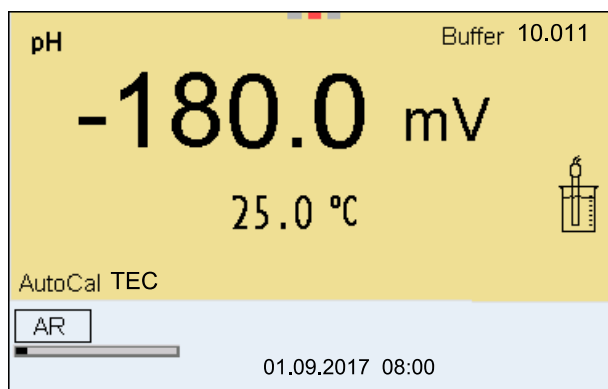

8. Wait for the end of the measurement with stability control or accept the calibration value with <ENTER>.  
The calibration display for the next buffer appears (voltage display).
9. If necessary, finish the calibration procedure as a single-point calibration with <M>.  
The calibration record is displayed.



For **single-point calibration**, the instrument uses the Nernst slope (-59.2 mV/pH at 25 °C) and determines the zero point of the IDS-pH sensor.

### Continuing with two-point calibration

10. Thoroughly rinse the sensor with deionized water.

11. Immerse the pH sensor in buffer solution 2.
12. When measuring without temperature sensor:  
Enter the temperature of the buffer with <▲><▼>.
13. Start the measurement with <ENTER>.  
The measured value is checked for stability (stability control).  
The [AR] status indicator is displayed. The measured parameter flashes.

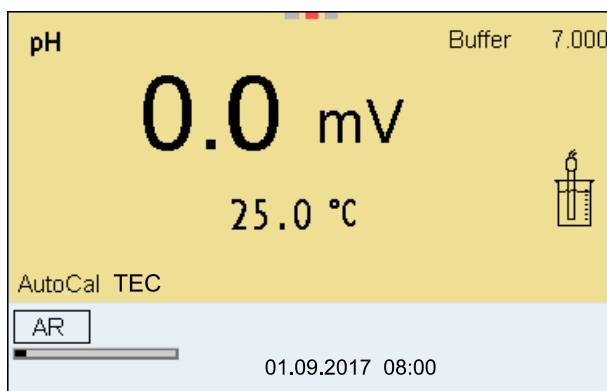

14. Wait for the measurement with stability control to be completed or terminate the stability control and take over the calibration value with <ENTER>.  
The calibration display for the next buffer appears (voltage display).
15. If necessary, finish the calibration procedure as a two-point calibration with <M>.  
The calibration record is displayed.

### Continuing with three- to five-point calibration

16. Thoroughly rinse the sensor with deionized water.
17. Immerse the sensor in the next buffer solution.
18. When measuring without temperature sensor:  
Enter the temperature of the buffer with <▲><▼>.
19. Start the measurement with <ENTER>.  
The measured value is checked for stability (stability control).  
The [AR] status indicator is displayed. The measured parameter flashes.

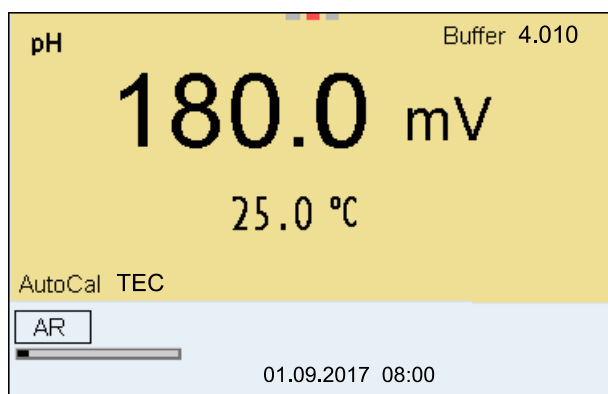

20. Wait for the measurement with stability control to be completed or terminate the stability control and take over the calibration value with **<ENTER>**.  
The calibration display for the next buffer appears (voltage display).
21. If necessary, use **<M>** to finish the calibration.  
The calibration record is displayed.  
or  
Switch to calibration with the next buffer with **<ENTER>**.



Calibration is automatically completed after the last buffer of a buffer set has been measured. Then the calibration record is displayed.

The calibration line is determined by linear regression.

#### 5.2.4 Carrying out a manual calibration (ConCal)

Make sure that in the sensor menu, *Buffer* menu, the ConCal buffer set is correctly selected (see section 11.1.1 SETTINGS FOR PH MEASUREMENTS, page 93).

Use one to five buffer solutions in any order.

The pH values of the buffer solutions have to differ by at least one pH unit.



If single-point calibration was set in the menu, the calibration procedure is automatically finished with the measurement of buffer solution 1 and the calibration record is displayed.

1. Connect the pH sensor to the meter.  
The pH measuring window is displayed.
2. Keep the buffer solutions ready.  
When measuring without temperature sensor:  
Temper the buffer solutions or measure the current temperature.
3. Start the calibration with **<CAL>**.  
The calibration display for the first buffer appears (voltage display).



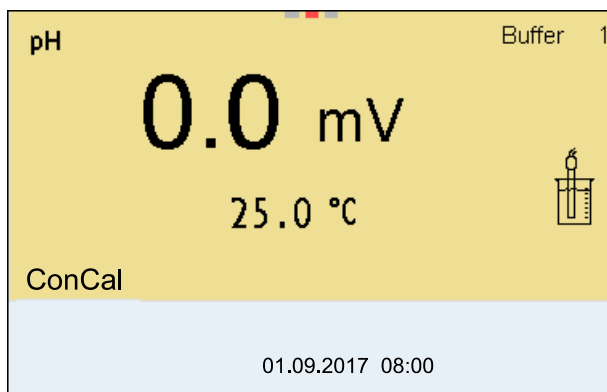

4. Thoroughly rinse the sensor with deionized water.
5. Immerse the pH sensor in buffer solution 1.
6. For measurements without temperature sensor (e.g. when using an IDS adapter):  
Enter the temperature of the buffer with <▲><▼>.
7. Start the measurement with <ENTER>.  
The measured value is checked for stability (stability control).  
The [AR] status indicator is displayed. The measured parameter flashes.

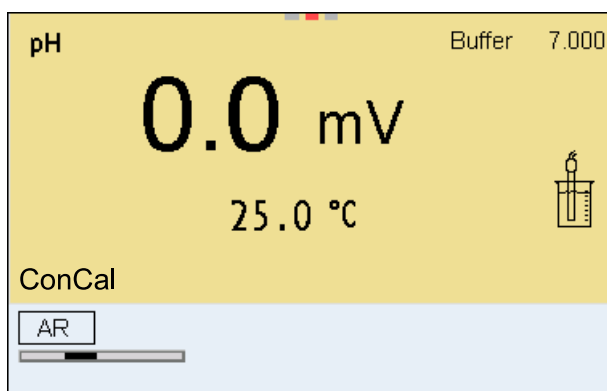

8. Wait for the measurement with stability control to be completed or terminate the stability control and take over the calibration value with <ENTER>.  
The pH value of the buffer solution is displayed.

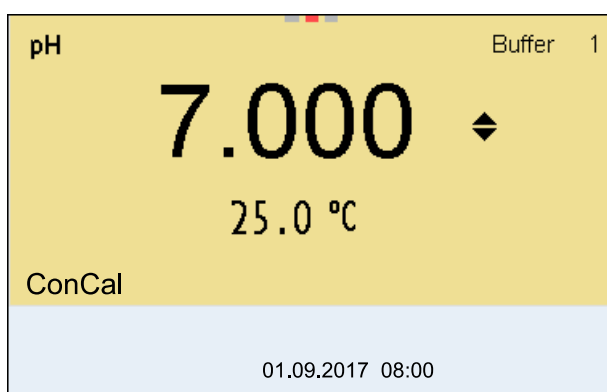

9. Set the nominal buffer value for the measured temperature with **<▲><▼>**.
10. Accept the calibration value with **<ENTER>**.  
The calibration display for the next buffer appears (voltage display).
11. If necessary, finish the calibration procedure as a single-point calibration with **<M>**.  
The calibration record is displayed.



For **single-point calibration**, the instrument uses the Nernst slope (-59.2 mV/pH at 25 °C) and determines the zero point of the IDS-pH sensor.

### Continuing with two-point calibration

12. Thoroughly rinse the sensor with deionized water.
13. Immerse the pH sensor in buffer solution 2.
14. When measuring without temperature sensor:  
Enter the temperature of the buffer with **<▲><▼>**.
15. Start the measurement with **<ENTER>**.  
The measured value is checked for stability (stability control).  
The [AR] status indicator is displayed. The measured parameter flashes.
16. Wait for the measurement with stability control to be completed or terminate the stability control and take over the calibration value with **<ENTER>**.  
The pH value of the buffer solution is displayed.

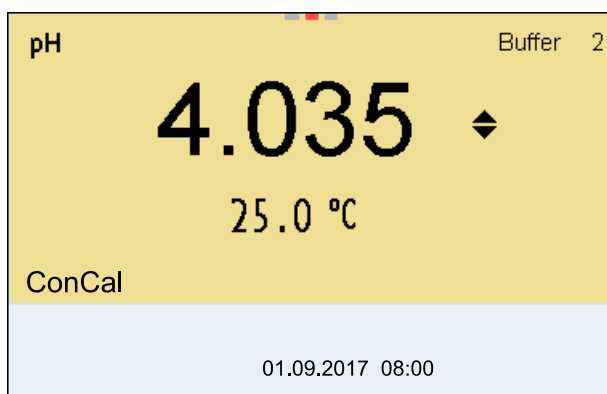

17. Set the nominal buffer value for the measured temperature with **<▲><▼>**.
18. Accept the calibration value with **<ENTER>**.  
The calibration display for the next buffer appears (voltage display).
19. If necessary, finish the calibration procedure as a two-point calibration with **<M>**.  
The calibration record is displayed.

### Continuing with three- to five-point calibration

20. Thoroughly rinse the sensor with deionized water.
21. Immerse the sensor in the next buffer solution.
22. When measuring without temperature sensor:  
Enter the temperature of the buffer with <▲><▼>.
23. Start the measurement with <ENTER>.  
The measured value is checked for stability (stability control).  
The [AR] status indicator is displayed. The measured parameter flashes.
24. Wait for the measurement with stability control to be completed or terminate the stability control and take over the calibration value with <ENTER>.  
The pH value of the buffer solution is displayed.

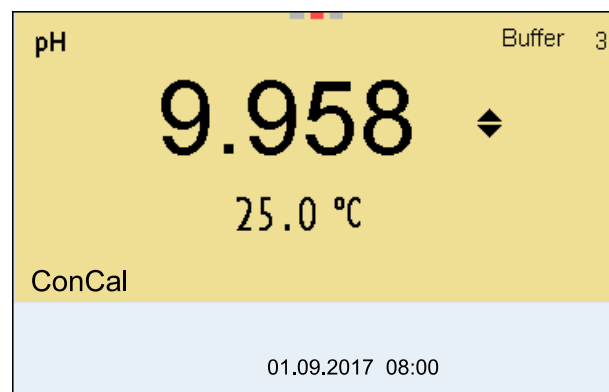

25. Set the nominal buffer value for the measured temperature with <▲><▼>.
26. Accept the calibration value with <ENTER>.  
The calibration display for the next buffer appears (voltage display).
27. If necessary, use <M> to finish the calibration.  
The calibration record is displayed.  
or  
Continue calibrating using the next buffer with <ENTER>.



After the fifth buffer has been measured the calibration is automatically finished. Then the calibration record is displayed.

The calibration line is determined by linear regression.

### 5.2.5 Calibration points

Calibration can be performed using one to five buffer solutions in any order (single-point to five-point calibration). The meter determines the following values and calculates the calibration line as follows:

Calibration	Determined values	Displayed calibration data
1-point	<i>Asy</i>	<ul style="list-style-type: none"> <li>● Zero point = <i>Asy</i></li> <li>● Slope = Nernst slope (-59.2 mV/pH at 25 °C)</li> </ul>
2-point	<i>Asy</i> <i>Slp.</i>	<ul style="list-style-type: none"> <li>● Zero point = <i>Asy</i></li> <li>● Slope = <i>Slp.</i></li> </ul>
3-point to 5-point	<i>Asy</i> <i>Slp.</i>	<ul style="list-style-type: none"> <li>● Zero point = <i>Asy</i></li> <li>● Slope = <i>Slp.</i></li> </ul> <p>The calibration line is calculated by linear regression.</p>



You can display the slope in the units, mV/pH or % (see section 11.1.1 SETTINGS FOR PH MEASUREMENTS, page 93).

### 5.2.6 Calibration data



The calibration record is automatically transmitted to the interface after calibrating.

#### Displaying the calibration data



The calibration record of the last calibration is available in the menu *Calibration / Calibration record*. To open it in the measured value display, press the **<CAL\_>** key.

The calibration records of the last 10 calibrations are available in the menu *Calibration / Calibration data storage / Display*. To open the *Calibration* menu in the measured value display, press the **<ENTER>** key.

Menu item	Setting/function	Explanation
<i>Calibration / Calibration data storage / Display</i>	-	Displays the calibration records. Further options: <ul style="list-style-type: none"> <li>● Scroll through the calibration records with &lt;◀&gt;&lt;▶&gt;.</li> <li>● Using &lt;PRT&gt;, output the displayed calibration record to the interface USB-B (<i>USB Device</i>, e.g. PC) or USB-A (<i>USB Host</i>, e.g. USB printer).</li> <li>● Using &lt;PRT_&gt;, output all calibration records to the interface USB-B (<i>USB Device</i>, e.g. PC) or USB-A (<i>USB Host</i>, e.g. USB printer).</li> <li>● Quit the display with &lt;ESC&gt;.</li> <li>● Switch directly to the measured value display with &lt;M&gt;.</li> </ul>
<i>Calibration / Calibration data storage / Output to USB flash drive or printer</i>	-	Outputs the stored calibration data to the USB-A interface ( <i>USB Host</i> , e.g. USB memory device/USB printer).
<i>Calibration / Calibration data storage / Output to RS232/USB</i>	-	Outputs the stored calibration data to the USB-B interface ( <i>USB Device</i> , e.g. PC)

### Calibration evaluation

After calibrating, the meter automatically evaluates the calibration. The zero point and slope are evaluated separately. The worse evaluation of both is taken into account. The evaluation appears on the display and in the calibration record.

Display	Calibration record	Zero point [mV]	Slope [mV/pH]
	+++	-15 ... +15	-60.5 ... -58.0
	++	-20 ... <-15 or >+15 ... +20	>-58.0 ... -57.0
	+	-25 ... <-20 or >+20 ... +25	-61.0 ... <-60.5 or >-57.0 ... -56.0

Display	Calibration record	Zero point [mV]	Slope [mV/pH]
 Clean the IDS sensor according to the sensor operating manual	-	-30 ... <-25 or >+25 ... +30	-62.0 ... <-61.0 or >-56.0 ... -50.0
<i>Error</i> Error elimination (see section 15 WHAT TO DO IF..., page 125)	<i>Error</i>	<-30 or >+30	<-62.0 or > -50,0



For pH IDS sensors you can optionally enable a more finely graded calibration evaluation (QSC) (see section 5.2.8 QSC FUNCTION (SENSOR QUALITY CONTROL), page 40).

### Calibration record

```

CALIBRATIONpH
01.09.2017 07:43:33
SenTix 940
Ser. no. B092500013

TEC
Buffer 1                4.01
Buffer 2                7.00
Buffer 3                10.01
Voltage 1               184.0 mV
Voltage 2                3.0 mV
Voltage 3              -177.0 mV
Temperature 1           24.0 °C
Temperature 2           24.0 °C
Temperature 3           24.0 °C

Slope                   -60.2 mV/pH
Asymmetry                4.0 mV
Sensor                  +++

etc...

```

### 5.2.7 Continuous measurement control (CMC function)

The Continuous Measurement Control (CMC function) facilitates to evaluate the current measured value instantly and definitely.

After each successful calibration the scale of the pH measuring range is displayed in the measured value display. Here you can very clearly see whether or not the current measured value is in the calibrated part of the measuring range.

The following information is displayed:

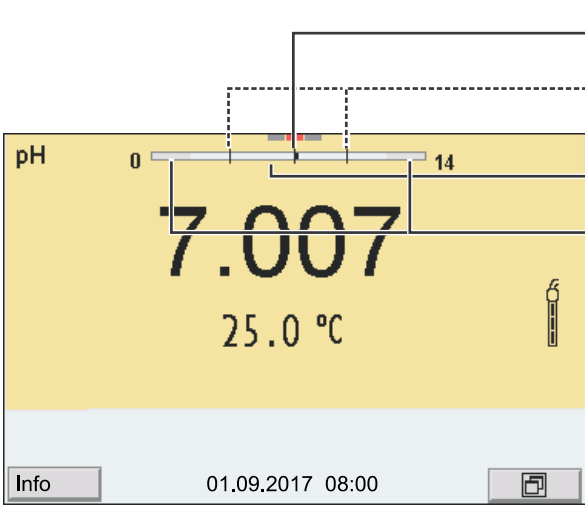

1 Currently measured pH value (needle)

2 Marking lines for all nominal buffer values used with the last valid calibration

3 Measuring range for which a valid calibration is available. Measured values in this range are suitable for documentation.

4 Measuring range for which no valid calibration is available (dark gray). Measured values in this range are not suitable for documentation. Calibrate the meter with buffers covering this measuring range. If the current measured value is outside the calibrated range, this area is displayed in a darker gray.  
If a measured value is outside the measuring range pH 0 - 14, overflow arrows are displayed at the left or right edge of the measuring range.

The limits of the calibrated range are determined by the buffers used for calibration:

Lower limit: Buffer with lowest pH value - 2 pH units

Upper limit: Buffer with highest pH value + 2 pH units

### 5.2.8 QSC function (sensor quality control)

#### General information on the QSC function

The QSC function (Quality Sensor Control) is a new sensor evaluation for digital IDS sensors. It evaluates the condition of an IDS pH sensor individually and with a very fine grading.

The QSC scale shows the current sensor evaluation with an indicator on the display.

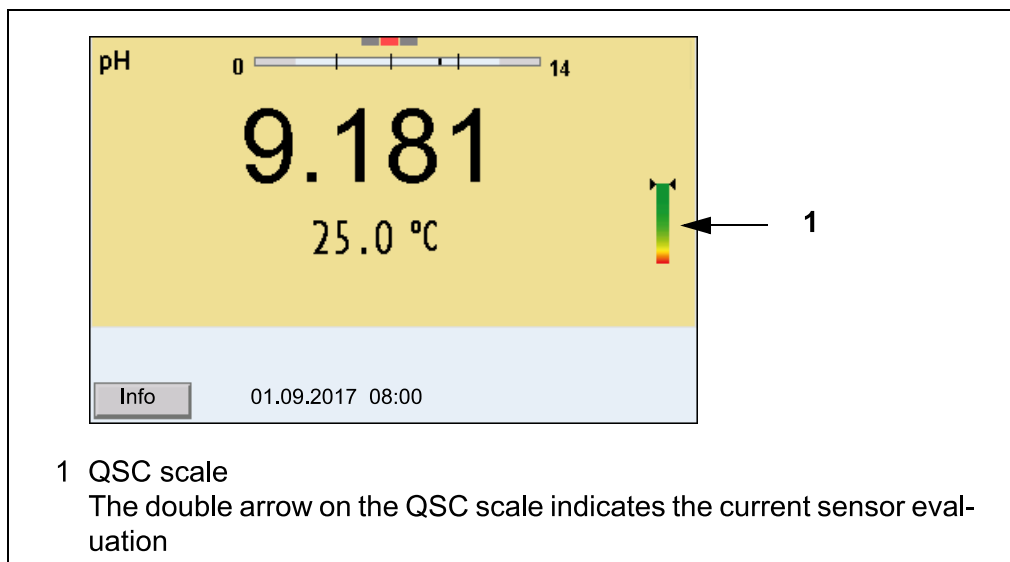

In the USB output the sensor evaluation is given as a percentage (1-100).

The finely graded sensor evaluation of the QSC function promptly calls your attention to changes of the sensor.

Thus you can do what is necessary to restore the optimum measuring quality (e.g. clean, calibrate or replace the sensor). clean, calibrate or replace the sensor).

#### Sensor evaluation with / without QSC function

With QSC function	Without QSC function (sensor symbol)
Very fine grading of the sensor evaluation (100 grades)	Rough grading of the sensor evaluation (4 grades)
The reference value is individually determined for each sensor during the QSC initial calibration.	A theoretical reference value is used for all sensors
Low tolerances for zero point and slope when using QSC buffer solutions	Greater tolerances for zero point and slope when using commercial buffer sets
Additional QSC calibration required (with special QSC buffer set)	No additional calibration required

#### QSC calibration

The QSC function is enabled by once carrying out an additional three-point calibration with special QSC buffer solutions. It covers the measuring range of the sensor from pH 2 to pH 11. The QSC initial calibration determines the actual condition of the sensor and stores it as a reference in the sensor.



To meet the high requirements of a QSC initial calibration, the QSC initial calibration should optimally be carried out with the initial commissioning of the sensor.

Carry out the normal calibrations for your special measuring range with your usual standard solutions as previously done.



As soon as the QSC function was enabled for an IDS sensor, it is not possible to return to the sensor evaluation with the sensor symbol for this sensor.

### Carrying out a QSC initial calibration

1. Open the menu for measurement settings with **<ENTER>**.
2. In the QSC menu, select *First calibration* with **<▲><▼>**. The calibration display appears. *AutoCal QSC-Kit* is displayed as the buffer. Exclusively use the QSC-Kit for the QSC calibration. If you use other buffers, you will have no valid QSC calibration.

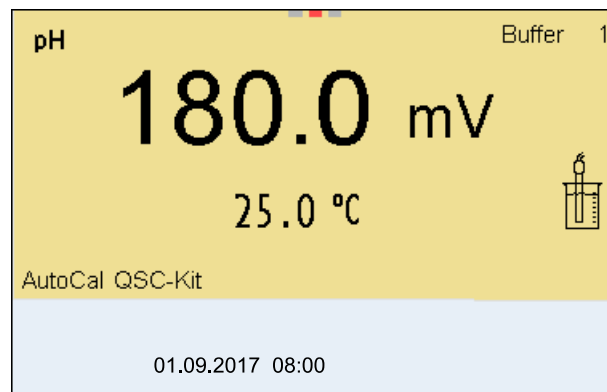

3. Calibration with the buffers of the QSC-Kit is done like a normal three-point calibration. Follow the user guide.



Carry out the QSC initial calibration very carefully. It determines the reference value for the sensor. This reference value cannot be overwritten or reset.

As soon as the QSC function was enabled, it is not possible to return to the sensor evaluation with the sensor symbol.

4. As soon as the three-point calibration has been successfully carried out you can decide whether to accept or discard the calibration as the QSC initial calibration.

The QSC initial calibration is completed. The sensor is calibrated. If you want to calibrate with special buffers for your measurements, you can subsequently carry out a normal calibration with your buffers. The reference values determined with the QSC calibration are also used for the evaluation of normal cali-

brations. In the measured value display, the QSC scale of the QSC function is always displayed. A double arrow on the QSC scale indicates the current sensor evaluation.

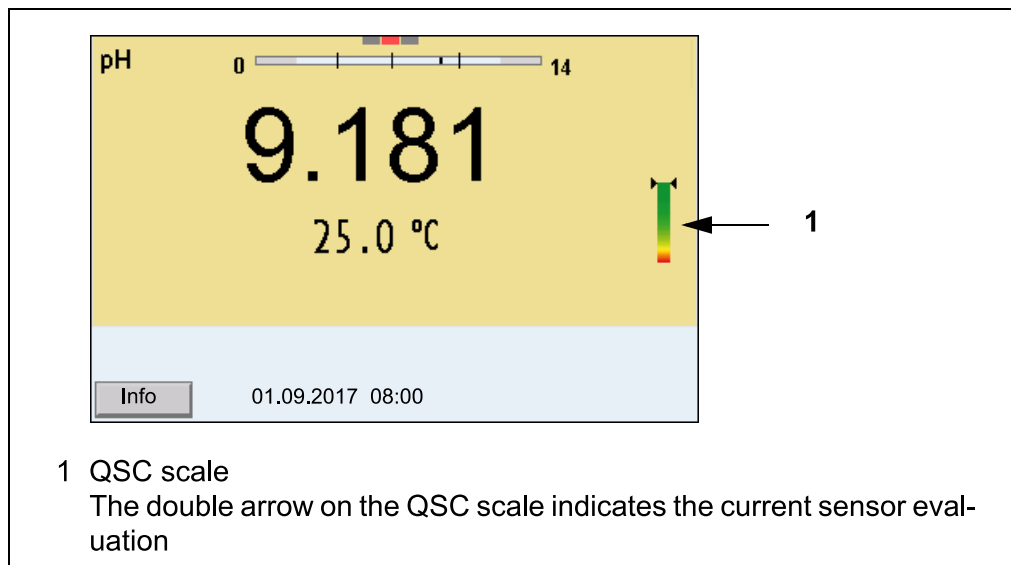

### Carrying out a QSC control calibration

A QSC control calibration can, e.g. be useful if the sensor evaluation noticeably changed (after some normal calibrations).

You can carry out QSC control calibrations at greater intervals than normal calibrations.

1. Open the menu for measurement settings with **<ENTER>**.
2. In the QSC menu, select *Control calibration* with **<▲><▼>**.  
The calibration display appears. *AutoCal QSC-Kit* is displayed as the buffer.  
Exclusively use the QSC-Kit for the QSC calibration. If you use other buffers, you will have no valid QSC control calibration.
3. Follow the user guide.  
The calibration is carried out like a normal three-point calibration. As soon as the three-point calibration has been successfully carried out you can decide whether to accept or discard the calibration as the QSC control calibration.

## 6 ORP

### 6.1 Measuring

#### 6.1.1 Measuring the ORP



The sensor connection and the USB-B (*USB Device*) interface are galvanically insulated. This facilitates interference-free measurements also in the following cases:

- Measurement in grounded test samples
- Measurement with several sensors connected to one Multi 9620 IDS in one test sample



IDS ORP sensors are not calibrated. However, you can check IDS ORP sensors using a test solution.

1. Connect the ORP sensor to the meter.  
The ORP measuring window is displayed.
2. Adjust the temperature of the solutions and measure the current temperature if the measurement is made without a temperature sensor.
3. Check the meter with the ORP sensor.
4. Immerse the ORP sensor in the test sample.

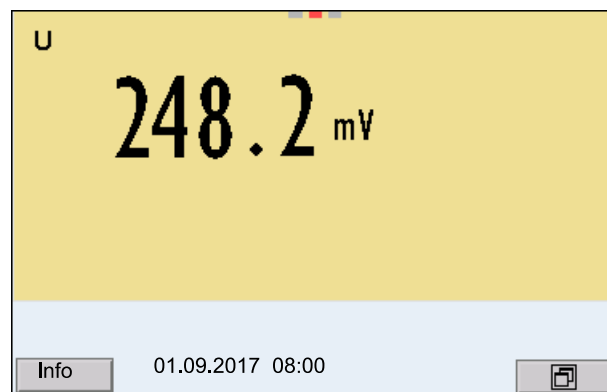

#### Stability control (AutoRead) & HOLD function

The stability control function (*AutoRead*) continually checks the stability of the measurement signal. The stability has a considerable impact on the reproducibility of measured values.

The measured parameter flashes on the display

- as soon as the measured value is outside the stability range
- when the automatic *Stability control* is switched off.

You can start the *Stability control* manually at any time, irrespective of the setting for automatic *Stability control* (see section 11.7.3 AUTOMATIC STABILITY CONTROL, page 107) in the *System* menu.

1. Freeze the measured value with **<AR>**.  
The [HOLD] status indicator is displayed.  
The HOLD function is active.



You can terminate the *Stability control* function and the HOLD function with **<AR>** or **<M>** at any time.

2. Using **<ENTER>**, activate the *Stability control* function manually.  
The [AR] status indicator appears while the measured value is assessed as not stable. A progress bar is displayed and the display of the measured parameter flashes.  
As soon as a measured value meets the stability criteria, it is frozen. The [HOLD][AR] status indicator is displayed, the progress bar disappears and the display of the measured parameter stops flashing.  
The current measurement data is output to the interface. Measurement data meeting the stability control criterion is marked by AR.



You can prematurely terminate the *Stability control* function manually with **<ENTER>** at any time. If the *Stability control* function is prematurely terminated, the current measurement data are output to the interfaces USB-B (*USB Device*, e.g. PC) and USB-A (*USB Host*, e.g. USB memory device or USB printer) without AutoRead info.

3. Using **<ENTER>**, start a further measurement with stability control.  
or  
Release the frozen measured value again with **<AR>** or **<M>**.  
The [AR] status display disappears. The display switches back to the previous indication.

#### Criteria for a stable measured value

The *Stability control* function checks whether the measured values are stable within the monitored time interval.

Measured parameter	Time interval	Stability in the time interval
ORP	15 seconds	$\Delta$ : better than 0.3 mV
Temperature	15 seconds	$\Delta$ : better than 0.5 °C

The minimum duration until a measured value is assessed as stable is the monitored time interval. The actual duration is mostly longer.

#### 6.1.2 Measuring the relative ORP

To measure the difference of the ORPs of two solutions, you have to define the ORP of one solution as the zero point first.



ORP electrodes can be used to determine the relative ORP.

1. Connect the ORP electrode to the meter.
2. Prepare the reference solution for the determination of the reference point.
3. Select the  $\Delta U$  (mV display with **<M>**).
4. Immerse the ORP electrode in the reference solution.
5. Display the potential of the current zero point with **<CAL>**.
6. Press **<ENTER>** to measure the reference solution.  
The measured value is checked for stability (automatic stability control). The display of the measured parameter flashes.  
The measured potential is defined as the zero point.  
or  
Press **<M>** to terminate the display of the zero point.
7. Rinse the ORP electrode and immerse it in the test sample.  
The measured value is checked for stability (automatic stability control). The display of the measured parameter flashes.
8. Wait for a stable measured value.  
The display of the measured parameter no longer flashes.



**AutoRead** The *Stability control* function checks whether the measured values are stable within the monitored time interval.

Measured parameter	Time interval	Stability in the time interval
ORP	15 seconds	$\Delta$ : better than 0.3 mV
Temperature	15 seconds	$\Delta$ : better than 0.5 °C

The minimum duration until a measured value is assessed as stable is the monitored time interval. The actual duration is mostly longer.

### 6.1.3 Measuring the temperature

For reproducible ORP measurements, it is essential to measure the temperature of the test sample.

When operating a sensor without integrated temperature sensor, you first have to measure and enter the temperature of the sample.

The measuring instrument recognizes whether a suitable sensor is connected and automatically switches on the temperature measurement.

The display of the temperature indicates the active temperature measuring mode:

Temperature sensor	Resolution of the temp. display	Temp. measurement
yes	0.1 °C	Automatic with temperature sensor
-	1 °C	Manual

## 6.2 ORP calibration



ORP electrodes are not calibrated. You can, however, check ORP electrodes by measuring the ORP of a test solution and comparing the value with the nominal value.

## 7 Ion concentration

### 7.1 Measuring

#### 7.1.1 Measuring the ion concentration



The sensor connection and the USB-B (*USB Device*) interface are galvanically insulated. This facilitates interference-free measurements also in the following cases:

- Measurement in grounded test samples
- Measurement with several sensors connected to one Multi 9620 IDS in one test sample



Incorrect calibration of ion sensitive electrodes will result in incorrect measured values. Calibrate regularly before measuring.



For precise ISE measurements the temperature difference between measurement and calibration should not be greater than 2 K. Therefore, adjust the temperature of the standard and measuring solutions accordingly. If the temperature difference is greater the *[TempErr]* warning appears in the measured value display.

1. Connect an ISE combination electrode to the meter with the aid of a ADA 94/IDS BNC or ADA 94/IDS DIN. The pH/ISE measuring window is displayed.
2. In the measured value display, select the ISE measuring window with **<▲>** **<▼>** and **<M>**.
3. Specify the ion type in the *ISE setup/Ion type* menu as necessary.
4. If necessary, measure the temperature of the test sample with a thermometer.
5. Calibrate or check the meter with the electrode.



While no valid calibration is available, e.g. in the delivery condition, "Error" appears in the measured value display.

6. Immerse the electrode in the test sample.

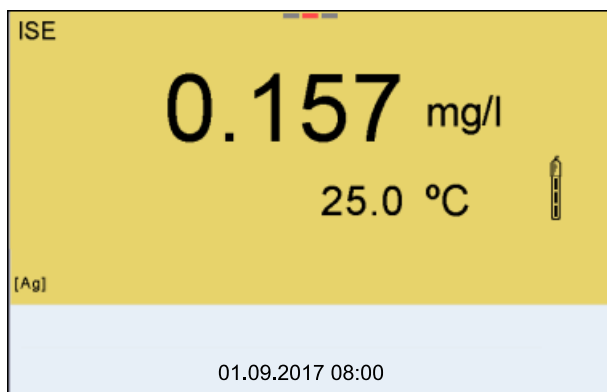

### Stability control (AutoRead) & HOLD function

The stability control function (*AutoRead*) continually checks the stability of the measurement signal. The stability has a considerable impact on the reproducibility of measured values.

The measured parameter flashes on the display

- as soon as the measured value is outside the stability range
- when the automatic *Stability control* is switched off.

You can activate or switch off the automatic *Stability control* function (see section 11.7.3 AUTOMATIC STABILITY CONTROL, page 107).

1. Freeze the measured value with **<AR>**.  
The [HOLD] status indicator is displayed.  
The HOLD function is active.



You can terminate the *Stability control* function and the HOLD function with **<AR>** or **<M>** at any time.

2. Using **<ENTER>**, activate the *Stability control* function manually. The [AR] status indicator appears while the measured value is assessed as not stable. A progress bar is displayed and the display of the measured parameter flashes. The [HOLD][AR] status indicator appears as soon as a stable measured value is recognized. The progress bar disappears and the display of the measured parameter stops flashing. The current measurement data is output to the interface. Measurement data meeting the stability control criterion is marked by AR.



You can prematurely terminate the *Stability control* function manually with **<ENTER>** at any time. If the *Stability control* function is prematurely terminated, the current measurement data are output to the interface without the AutoRead info.



3. Using **<ENTER>**, start a further measurement with stability control.  
or  
Release the frozen measured value again with **<AR>** or **<M>**.  
The [AR] status display disappears. The display switches back to the previous indication.

**Criteria** The AutoRead criteria affect the reproducibility of the measured values. The following criteria can be adjusted:

- *high*: highest reproducibility
- *medium*: medium reproducibility
- *low*: lowest reproducibility



Increasing reproducibility also causes the response time to increase until a measured value is evaluated as stable.

### 7.1.2 Measuring the temperature

For reproducible ion-selective measurements, it is essential to measure the temperature of the test sample.

You have the following options to measure the temperature:

- Measurement by an external temperature sensor.
- Manual determination and input of the temperature.

The measuring instrument recognizes whether a suitable sensor is connected and automatically switches on the temperature measurement.

The display of the temperature indicates the active temperature measuring mode:

Temperature sensor	Resolution of the temp. display	Temp. measurement
yes	0.1 °C	Automatic with temperature sensor
-	1 °C	Manual

If you wish to measure (or calibrate) without temperature sensor, proceed as follows:

1. Measure the current temperature of the test sample.
2. Set the temperature value with **<▲><▼>**.  
or  
In the **<ENTER>/ISE/Man. temperature** menu, set the temperature value with **<▲><▼>**.

## 7.2 Calibration

### 7.2.1 Why calibrate?

Ion-selective electrodes age and are temperature-dependent. This changes the slope. As a result, an inexact measured value is displayed. Calibration determines the calibration line of the electrode and stores this value in the meter.

Thus, you should calibrate before each measurement (if possible), and at regular intervals.

### 7.2.2 When to calibrate?

- Before any measurement if possible
- After connecting another ISE electrode

### 7.2.3 Calibration (ISE Cal)

ISE Cal is the conventional **two-point to seven-point calibration procedure** that uses 2 to 7 freely selectable standard solutions. The concentration expected in the measurement determines the concentration of the calibration standards.

1. Connect the ISE electrode to the meter.  
The pH/mV/ISE measuring window is displayed.
2. Keep the standard solutions ready.
3. If necessary, measure the temperature of the standard solutions with a thermometer.
4. In the measured value display, select the ISE measuring window with **<▲>** **<▼>** and **<M>**.
5. Specify the ion type in the *ISE setup/Ion type* menu as necessary.
6. If necessary, change the unit of the measurement result and calibration standards in the *ISE setup/Unit* menu.
7. Start the calibration with **<CAL>**.  
The calibration display appears.

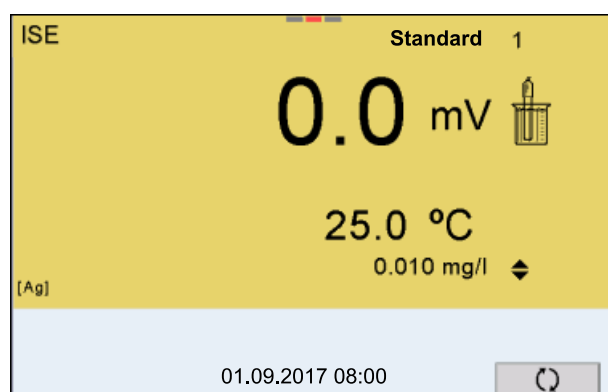

8. Thoroughly rinse the electrode with distilled water.
9. Immerse the electrode in standard solution 1.
10. When calibrating without temperature sensor:
  - Measure the temperature of the standard solution using a thermometer.
  - Use <F4>/[ ↑ ] to select the setting of the temperature.
  - Use <▲> <▼> to set the temperature.
  - Use <F4>/[ ↑ ] to select the setting of the concentration.
11. Set the concentration of the standard solution with <▲> <▼> and press <ENTER>.
 

The standard solution is measured.  
The measured value is checked for stability (AutoRead).

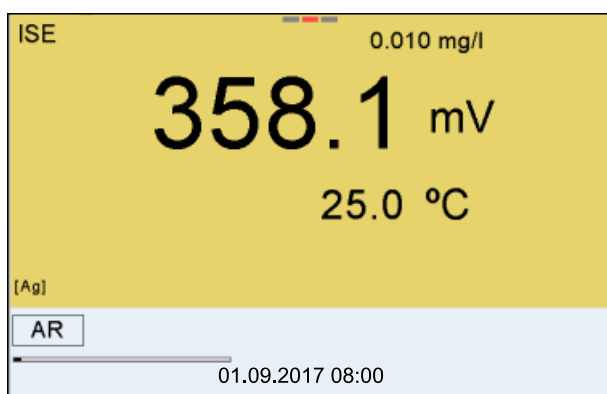

12. Wait for the end of the AutoRead measurement or accept the calibration value with <ENTER>.
 

The calibration display for the next standard solution appears.

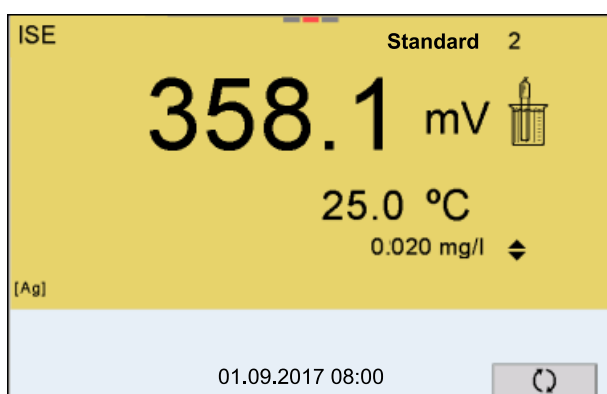

### Continuing with two-point calibration

13. Thoroughly rinse the electrode with distilled water.
14. Immerse the electrode in standard solution 2.

15. When calibrating without temperature sensor:
  - Measure the temperature of the standard solution using a thermometer.
  - Use <F4>/[  $\updownarrow$  ] to select the setting of the temperature.
  - Use <▲> <▼> to set the temperature.
  - Use <F4>/[  $\updownarrow$  ] to select the setting of the concentration.
16. Set the concentration of the standard solution with <▲> <▼> and press <ENTER>.
 

The standard solution is measured.  
The measured value is checked for stability (AutoRead).

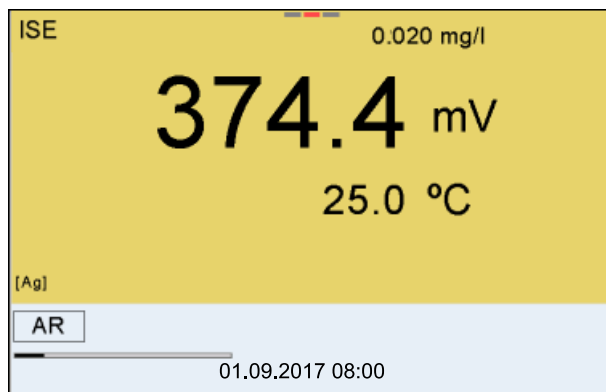

17. Wait for the end of the AutoRead measurement or accept the calibration value with <ENTER>.
 

The calibration display for the next standard solution appears.

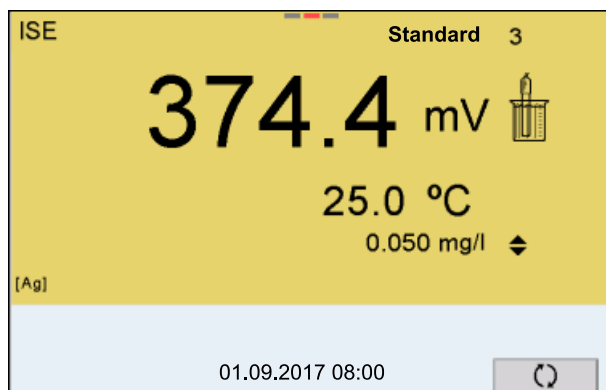

18. Press <ENTER> to continue with three-point calibration.  
or  
Finish the calibration procedure as a two-point calibration with <M>.
 

The new calibration values are displayed.

### Continuing with three- to seven-point calibration

Repeat the steps 12 to 17 in the same way with the third and further standard solutions as necessary. The new calibration values are displayed after the last calibration step was completed.



Based on the calibration data, the calibration curve is determined in sections, according to the Nernst equation modified by Nikolski.

### 7.2.4 Calibration standards

Use two to seven different standard solutions. The standard solutions have to be selected in either increasing or decreasing order.



Select the unit of the standard solution and measurement result in the *ISE setup/Unit* menu.

Standard solution (Std 1 - 7)	Values
Unit [mg/l]	0.010 ... 500,000
Unit [mol/l]	0.100 ... 5.000 µmol/l 10.00 ... 5.000 mmol/l
Unit [mg/kg]	0.010 ... 500.000
Unit [ppm]	0.010 ... 500.000
Unit [%]	0.001 ... 50.000



The measurement precision is also dependent on the selected standard solutions. Therefore, the selected standard solutions should cover the value range expected of the following concentration measurement.

If the measured electrode potential is outside the calibrated range, the *[ISEErr]* warning is displayed.

### 7.2.5 Calibration data



The calibration record is automatically transmitted to the interface after calibrating.

#### Displaying the calibration data

The calibration record of the last calibration is available in the menu *Calibration / Calibration record*. To open it in the measured value display, press the **<CAL\_>** key.

The calibration records of the last 10 calibrations are available in the menu *Calibration / Calibration data storage / Display*. To open the *Calibration* menu in the measured value display, press the **<ENTER>** key.

Menu item	Setting/function	Explanation
<i>Calibration / Calibration data storage / Display</i>	-	Displays the calibration records. Further options: <ul style="list-style-type: none"> <li>● Scroll through the calibration records with &lt;◀&gt;&lt;▶&gt;.</li> <li>● Using &lt;PRT&gt;, output the displayed calibration record to the interface USB-B (<i>USB Device</i>, e.g. PC) or USB-A (<i>USB Host</i>, e.g. USB printer).</li> <li>● Using &lt;PRT_&gt;, output all calibration records to the interface USB-B (<i>USB Device</i>, e.g. PC) or USB-A (<i>USB Host</i>, e.g. USB printer).</li> <li>● Quit the display with &lt;ESC&gt;.</li> <li>● Switch directly to the measured value display with &lt;M&gt;.</li> </ul>
<i>Calibration / Calibration data storage / Output to USB flash drive or printer</i>	-	Outputs the stored calibration data to the USB-A interface ( <i>USB Host</i> , e.g. USB memory device or USB printer).
<i>Calibration / Calibration data storage / Output to RS232/USB</i>	-	Outputs the stored calibration data to the USB-B interface ( <i>USB Device</i> , e.g. PC)

### Calibration evaluation

After calibrating, the meter automatically evaluates the calibration.

Display	Calibration record	Magnitude of the slope [mV]
	+++	30.0 ... 90.0 * or 15.0 ... 45.0 **
<i>Error</i>	<i>Error</i>	< 30 or > 90 * or < 15 or > 45 **
Error elimination (see section 15.2 ISE, page 127)		* Monovalent ions ** Bivalent ions

**Calibration record  
(example)**

```
Multi 9620 IDS
Ser. no. 12345678

CALIBRATIONISE
01.09.2017 08:09:10

Sensor
Ser. no. 12345678

Standard 1          0.010 mg/l
Standard 2          0.020 mg/l
Voltage 1           358.1 mV
Voltage 2           374.4 mV
Temperatur 1        25.0 °C
Temperatur 2        25.0 °C
Ion type            Ag
Slope               54.1 mV
Sensor              +++
```

### 7.3 Selecting the measuring method

The following methods are supported:

- *Standard addition*
- *Standard subtraction*
- *Sample addition*
- *Sample subtraction*
- *Blank value addition*

1. Connect the ISE electrode to the meter.  
The pH/ISE measuring window is displayed.
2. If necessary, select the ISE display with **<M>**.
3. If necessary, measure the temperature of the test sample with a thermometer.
4. Open the ISE menu with **<ENTER>**.
5. Thoroughly rinse the electrode with distilled water.
6. Adjust the temperature of the standard solutions.
7. Select *Method* with **<▲>** **<▼>** and confirm with **<ENTER>**.
8. Select a method with **<▲>** **<▼>** and confirm with **<ENTER>**.

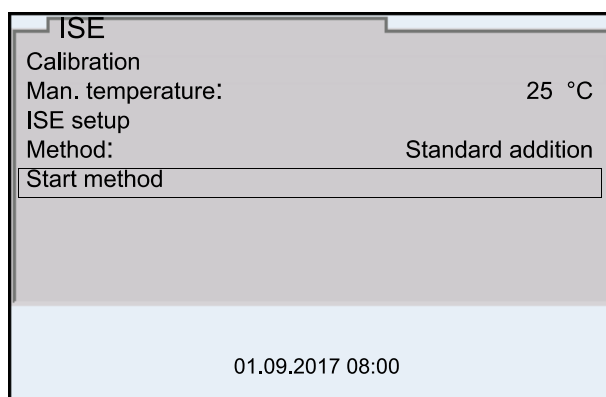

9. Select *Start method* with **<▲>** **<▼>** and confirm with **<ENTER>**.  
Measurement with the selected method begins (see section 7.3.1 STANDARD ADDITION, page 57 ... section 7.3.5 STANDARD ADDITION WITH BLANK VALUE CORRECTION (BLANK VALUE ADDITION), page 67).



### 7.3.1 Standard addition

In the "Standard addition" procedure, a known amount of standard solution is added to the sample.

The ion concentration in the sample is calculated from the change in potential.

1. Select the measuring method (see section 7.3 SELECTING THE MEASURING METHOD, page 56).
2. Prepare two standard calibration solutions.
3. Perform a two-point calibration according to user guidance.
4. The calibration record is displayed as soon as a stable value is achieved for the second standard calibration solution.

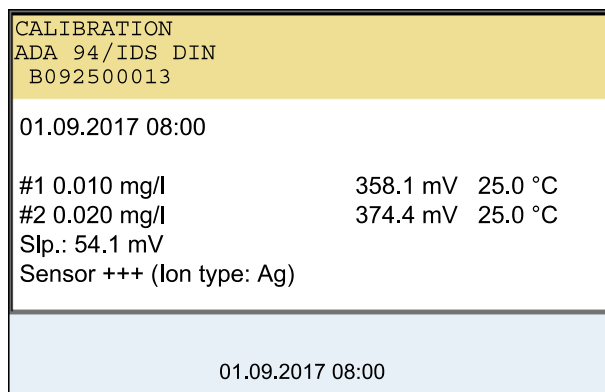

### Measurement

5. Start the measurement with <F1>/[Continue]. An entry window appears.

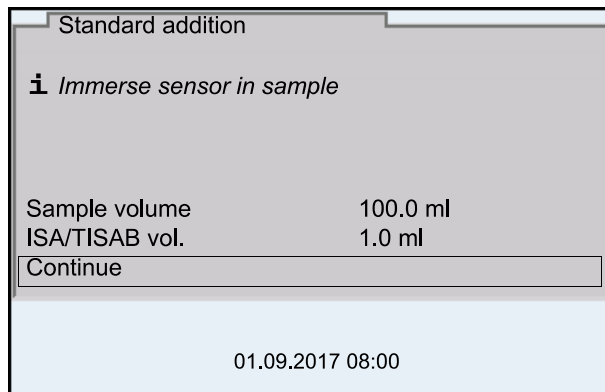

6. Prepare the sample.
7. If necessary, add the ISA/TISAB solution to the sample.
8. Thoroughly rinse the electrode with deionized water.
9. Immerse the electrode in the sample.
10. Using <▲> <▼> and <ENTER>, select the values for the volume of the sample (*Sample volume*) and the volume of the ISA/TISAB solution (*ISA/TISAB vol.*).

11. Select *Continue* with <▲> <▼> and start the measurement with <ENTER>. When the measurement is finished an entry window appears.

12. Add the standard solution to the sample.
13. Using <▲> <▼> and <ENTER>, enter the values for the volume of the standard solution (*Std. volume*) and concentration of the standard solution (*Std. conc.*).
14. Select *Continue* with <▲> <▼> and start the measurement with <ENTER>. The measurement result is displayed when the measurement is completed.

15. If necessary, start measuring further samples with <ENTER>. Repeat steps 6 - 14 for all samples.
16. Terminate the measuring method with <M>. A safety query appears.
17. Select yes with <▲> <▼>.
18. Using <ENTER>, confirm yes. Measurement with the selected method is completed.

### 7.3.2 Standard subtraction

In the "Standard Subtraction" procedure, a known amount of standard solution is added to the sample (as complexing agent or precipitating agent) and, thus, the ion concentration lowered.

The ion concentration in the sample is calculated from the change in potential.

1. Select the measuring method (see section 7.3 SELECTING THE MEASURING METHOD, page 56).

#### Calibration

2. Prepare two standard calibration solutions.
3. Perform a two-point calibration according to user guidance.
4. The calibration record is displayed as soon as a stable value is achieved for the second standard calibration solution.

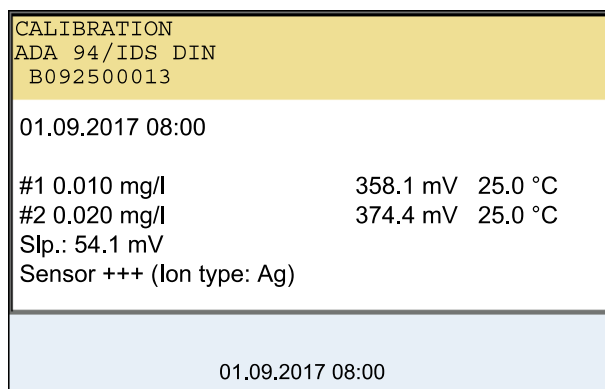

#### Measurement

5. Start the measurement with <F1>/[Continue]. An entry window appears.

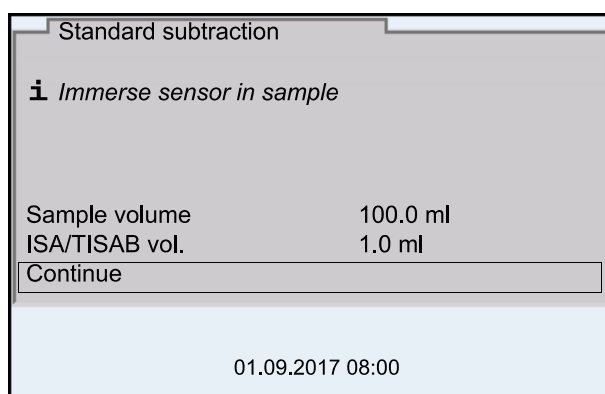

6. Prepare the sample.
7. If necessary, add the ISA/TISAB solution to the sample.
8. Thoroughly rinse the electrode with deionized water.

9. Immerse the electrode in the sample.
10. Using **<▲>** **<▼>** and **<ENTER>**, select the values for the volume of the sample (*Sample volume*) and the volume of the ISA/TISAB solution (*ISA/TISAB vol.*).
11. Select *Continue* with **<▲>** **<▼>** and start the measurement with **<ENTER>**.  
When the measurement is finished an entry window appears.

12. Add the standard (complexing agent or precipitating agent) to the sample.
13. Using **<▲>** **<▼>** and **<ENTER>**, enter the values for the volume of the standard solution (*Std. volume*) and concentration of the standard solution (*Std. conc.*).
14. Using **<▲>** **<▼>** and **<ENTER>**, set the ion type for the ion in the standard (*Ion type*) if necessary.  
On selection of the ion type that can be defined (ION):  
Using **<▲>** **<▼>** and **<ENTER>**, set the valence (*Valency*) and molar weight (*Molar mass*) for the ion in the standard solution.
15. Select *Continue* with **<▲>** **<▼>** and start the measurement with **<ENTER>**.  
The measurement result is displayed when the measurement is completed.

16. If necessary, start measuring further samples with **<ENTER>**.  
Repeat steps 6 - 15 for all samples.

17. Terminate the measuring method with **<M>**.  
A safety query appears.
18. Select *yes* with **<▲>** **<▼>**.
19. Using **<ENTER>**, confirm *yes*.  
Measurement with the selected method is completed.

### 7.3.3 Sample addition

In the "Sample addition" procedure, a known amount of sample is added to the standard solution.

The ion concentration in the sample is calculated from the change in potential.

1. Select the measuring method (see section 7.3 SELECTING THE MEASURING METHOD, page 56).

#### Calibration

2. Prepare two standard calibration solutions.
3. Perform a two-point calibration according to user guidance.
4. The calibration record is displayed as soon as a stable value is achieved for the second standard calibration solution.

CALIBRATION		
ADA 94/IDS DIN		
B092500013		
01.09.2017 08:00		
#1 0.010 mg/l	358.1 mV	25.0 °C
#2 0.020 mg/l	374.4 mV	25.0 °C
Slp.: 54.1 mV		
Sensor +++ (Ion type: Ag)		
01.09.2017 08:00		

#### Measurement

5. Start the measurement with **<F1>**[Continue].  
An entry window appears.

Sample addition	
<b>i</b> Immerse sensor in standard	
Std. volume	100.0 ml
Std. conc.	1.0 mg/l
ISA/TISAB vol.	1.0 ml
Continue	
01.09.2017 08:00	

6. Prepare the standard solution.
7. If necessary, add the ISA/TISAB solution to the standard solution.
8. Thoroughly rinse the electrode with deionized water.
9. Immerse the electrode in the standard.

10. Using **<▲>** **<▼>** and **<ENTER>**, enter the values for the volume of the standard solution (*Std. volume*), the concentration of the standard solution (*Std. conc.*) and the volume of the ISA/TISAB solution (*ISA/TISAB vol.*).
11. Select *Continue* with **<▲>** **<▼>** and start the measurement with **<ENTER>**.  
When the measurement is finished an entry window appears.

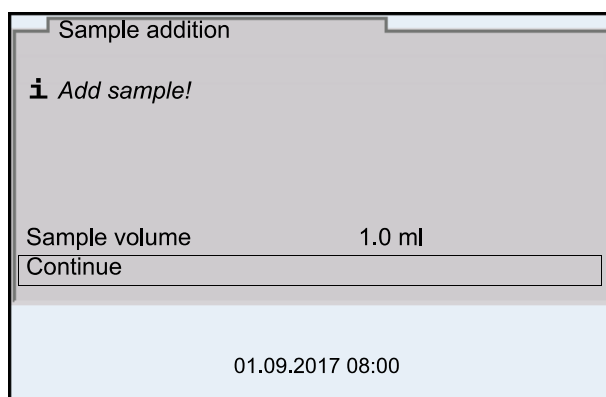

12. Add the sample to the standard solution.
13. Using **<▲>** **<▼>** and **<ENTER>**, enter the value for the volume of the sample (*Sample volume*).
14. Select *Continue* with **<▲>** **<▼>** and start the measurement with **<ENTER>**.  
The measurement result is displayed when the measurement is completed.

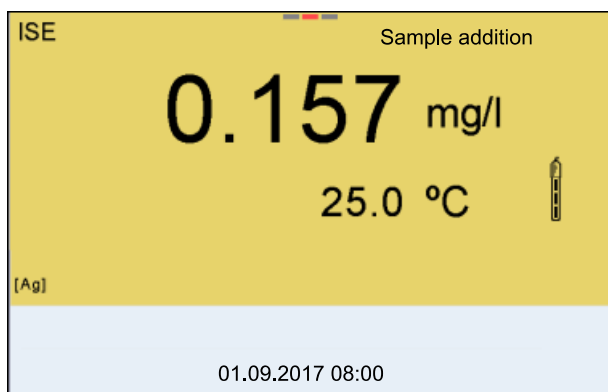

15. If necessary, start measuring further samples with **<ENTER>**.  
Repeat steps 6 - 14 for all samples.
16. Terminate the measuring method with **<M>**.  
A safety query appears.
17. Select yes with **<▲>** **<▼>**.
18. Using **<ENTER>**, confirm yes.  
Measurement with the selected method is completed.

### 7.3.4 Sample subtraction

With the Sample subtraction procedure, a known amount of sample is added to the standard solution (complexing agent or precipitating agent).

The ion concentration in the sample is calculated from the change in potential. The sample subtraction is one method for the indirect determination of ions. It is used for the determination of ions for which no direct determination is possible.

1. Select the measuring method (see section 7.3 SELECTING THE MEASURING METHOD, page 56).  
An entry window appears.

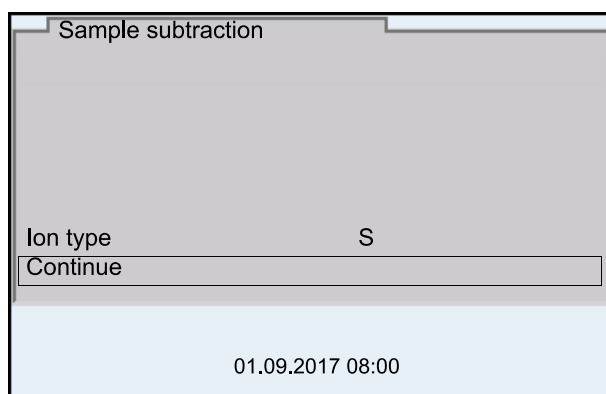

2. Using **<▲>** **<▼>** and **<ENTER>**, set the ion type for the ion in the standard (*Ion type*) as necessary.  
On selection of the ion type that can be defined (ION):  
Using **<▲>** **<▼>** and **<ENTER>**, set the valence (*Valency*) and molar weight (*Molar mass*) for the ion in the standard solution.
3. Select and confirm *Continue* with **<▲>** **<▼>** and **<ENTER>**.

### Calibration

4. Prepare two standard calibration solutions.
5. Perform a two-point calibration according to user guidance.
6. The calibration record is displayed as soon as a stable value is achieved for the second standard calibration solution.

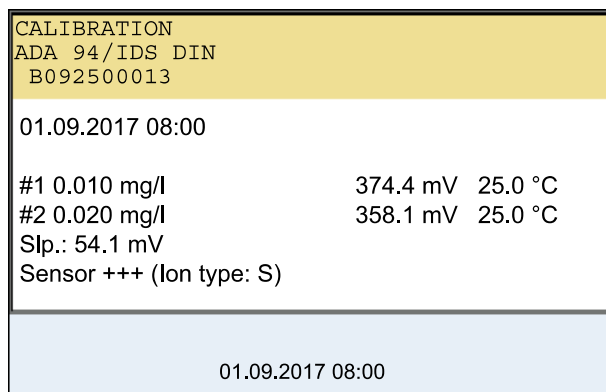



## Measurement

7. Start the measurement with **<F1>** *Continue*  
An entry window appears.

8. Prepare the standard solution.
9. If necessary, add the ISA/TISAB solution to the standard solution.
10. Thoroughly rinse the electrode with deionized water.
11. Immerse the electrode in the standard solution (complexing agent or precipitating agent).
12. Using **<▲>** **<▼>** and **<ENTER>**, enter the values for the volume of the standard solution (*Std. volume*), the concentration of the standard solution (*Std. conc.*) and the volume of the ISA/TISAB solution (*ISA/TISAB vol.*).
13. Select *Continue* with **<▲>** **<▼>** and start the measurement with **<ENTER>**.  
When the measurement is finished an entry window appears.

14. Add the sample to the standard (complexing agent or precipitating agent).
15. Using **<▲>** **<▼>** and **<ENTER>**, enter the value for the volume of the sample (*Sample volume*).
16. Select *Continue* with **<▲>** **<▼>** and start the measurement with **<ENTER>**.  
The measurement result is displayed when the measurement is completed.

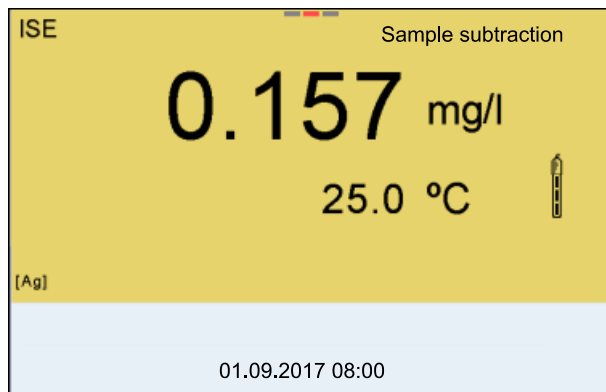

17. If necessary, start measuring further samples with **<ENTER>**. Repeat steps 8 - 16 for all samples.
18. Terminate the measuring method with **<M>**. A safety query appears.
19. Select yes with **<▲>** **<▼>**.
20. Using **<ENTER>**, confirm yes. Measurement with the selected method is completed.

### 7.3.5 Standard addition with blank value correction (Blank value addition)

In the "Standard addition with blank value correction" procedure, a known amount of standard solution is added to the sample in two steps.

The ion concentration in the linear range of the electrode characteristic curve is increased with the first addition.

The second addition is equivalent to the standard addition. The ion concentration in the sample is calculated from the change in potential.

1. Select the measuring method (see section 7.3 SELECTING THE MEASURING METHOD, page 56).

#### Calibration

2. Prepare two standard calibration solutions.
3. Perform a two-point calibration according to user guidance.
4. The calibration record is displayed as soon as a stable value is achieved for the second standard calibration solution.

CALIBRATION		
ADA 94/IDS DIN		
B092500013		
01.09.2017 08:00		
#1 0.010 mg/l	358.1 mV	25.0 °C
#2 0.020 mg/l	374.4 mV	25.0 °C
Slp.: 54.1 mV		
Sensor +++ (Ion type: Ag)		
01.09.2017 08:00		

#### Measurement

5. Start the measurement with **<F1>** *Continue*  
An entry window appears.

Blank value addition	
<b>i</b> Immerse sensor in sample	
Sample volume	100.0 ml
ISA/TISAB vol.	1.0 ml
BV volume	100.0 ml
BV conc.	1.000 mg/l
Continue	
01.09.2017 08:00	

6. Prepare the sample.
7. If necessary, add the ISA/TISAB solution to the sample.
8. Thoroughly rinse the electrode with deionized water.

9. Immerse the electrode in the sample that was supplemented with blank value solution.
10. Using **<▲>** **<▼>** and **<ENTER>**, enter the values for the volume of the sample (*Sample volume*), the volume of the ISA/TISAB solution (*ISA/TISAB vol.*), the volume of the blank value solution (*BV volume*) and the concentration of the blank value solution (*BV conc.*).
11. Select *Continue* with **<▲>** **<▼>** and start the measurement with **<ENTER>**.  
When the measurement is finished an entry window appears.

12. Add the standard solution to the sample.
13. Using **<▲>** **<▼>** and **<ENTER>**, enter the values for the volume of the standard solution (*Std. volume*) and concentration of the standard solution (*Std. conc.*).
14. Select *Continue* with **<▲>** **<▼>** and start the measurement with **<ENTER>**.  
The measurement result is displayed when the measurement is completed.

15. If necessary, start measuring further samples with **<ENTER>**.  
Repeat steps 6 - 12 for all samples.
16. Terminate the measuring method with **<M>**.  
A safety query appears.
17. Select yes with **<▲>** **<▼>**.
18. Using **<ENTER>**, confirm yes.  
Measurement with the selected method is completed.



## 8 Dissolved oxygen

### 8.1 Measuring

#### 8.1.1 Measuring D.O.



The sensor connection and the USB-B (*USB Device*) interface are galvanically insulated. This facilitates interference-free measurements also in the following cases:

- Measurement in grounded test samples
- Measurement with several sensors connected to one Multi 9620 IDS in one test sample

1. Connect the IDS-D.O. sensor to the meter. The D.O. measuring screen is displayed.
2. If necessary, select the measured parameter with **<M>**.
3. Check or calibrate the meter with the sensor.



Only in special cases does the FDO® 925-D.O. sensor require calibration. Regular FDO® Checks are sufficient.

4. Immerse the D.O. sensor in the test sample.

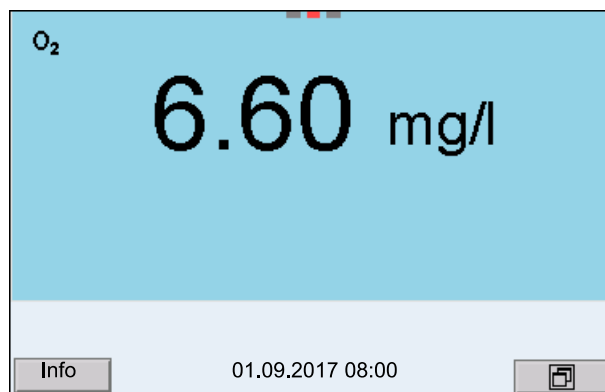

#### Selecting the displayed measured parameter

You can switch between the following displays with **<M>**:

- D.O. concentration [mg/l]
- D.O. saturation [%]
- D.O. partial pressure [mbar].

#### Salinity correction

When measuring the D.O. concentration [mg/l] of solutions with a salt content of more than 1 g/l a salinity correction is required. For this, you have to mea-

sure and input the salinity of the measured medium first.

When the salinity correction is switched on, the [Sal] indicator is displayed in the measuring screen.



You can switch the salinity correction on or off and enter the salinity in the menu for calibration and measurement settings (see section 11.4.1 SETTINGS FOR D.O. MEASUREMENT, page 101).

**Air pressure correction** The air pressure is automatically used for air pressure correction during calibrating and for the display of the oxygen saturation [%] parameter.

You can view the current air pressure in the sensor menu when an IDS D.O. sensor is connected. In the measured value display, press the <ENTER> key. The current air pressure is displayed as a piece of information.

### Stability control (AutoRead) & HOLD function

The stability control function (*AutoRead*) continually checks the stability of the measurement signal. The stability has a considerable impact on the reproducibility of measured values.

The measured parameter flashes on the display

- as soon as the measured value is outside the stability range
- when the automatic *Stability control* is switched off.

Irrespective of the setting for automatic *Stability control* (see section 11.7.3 AUTOMATIC STABILITY CONTROL, page 107) in the *System* menu, you can start a measurement with *Stability control* manually at any time.

1. Freeze the measured value with <AR>. The [HOLD] status indicator is displayed. The HOLD function is active.



You can terminate the *Stability control* function and the HOLD function with <AR> or <M> at any time.

2. Using <ENTER>, activate the *Stability control* function manually. The [AR] status indicator appears while the measured value is assessed as not stable. A progress bar is displayed and the display of the measured parameter flashes. As soon as a measured value meets the stability criteria, it is frozen. The [HOLD][AR] status indicator is displayed, the progress bar disappears and the display of the measured parameter stops flashing. The current measurement data is output to the interface. Measurement data meeting the stability control criterion is marked by AR.



You can prematurely terminate the *Stability control* function manually with **<ENTER>** at any time. If the *Stability control* function is prematurely terminated, the current measurement data are output to the interfaces USB-B (*USB Device*, e.g. PC) and USB-A (*USB Host*, e.g. USB memory device or USB printer) without AutoRead info.

3. Using **<ENTER>**, start a further measurement with stability control.  
or  
Release the frozen measured value again with **<AR>** or **<M>**.  
The [AR] status display disappears. The display switches back to the previous indication.

#### Criteria for a stable measured value

The *Stability control* function checks whether the measured values are stable within the monitored time interval.

Measured parameter	Time interval	Stability in the time interval
D.O. concentration	20 seconds	$\Delta$ : better than 0.03 mg/l
D.O. saturation	20 seconds	$\Delta$ : better than 0.4 %
D.O. partial pressure	20 seconds	$\Delta$ : Better than 0.8 mbar
Temperature	15 seconds	$\Delta$ : better than 0.5 °C

The minimum duration until a measured value is assessed as stable is the monitored time interval. The actual duration is mostly longer.

#### 8.1.2 Measuring the temperature

For reproducible D.O. measurements, it is essential to measure the temperature of the test sample.

IDS D.O. sensors measure the temperature with a temperature sensor integrated in the IDS sensor.



## 8.2 FDO® Check (checking the FDO 925)

### 8.2.1 Why should you check the sensor?

With the FDO® Check procedure you can find out in a simple manner whether the FDO® 925 D.O. sensor should be cleaned or calibrated.

### 8.2.2 When should you check the sensor?

Checking can be useful in the following cases:

- When the check interval has expired (the [check] status indicator is displayed).
- If the measured values seem to be implausible
- If you assume that the sensor cap is contaminated or at the end of its lifetime
- After the sensor cap was exchanged
- Routinely within the framework of the company quality assurance

### 8.2.3 Perform a FDO® Check

#### **FDO® Check procedure**

#### **Stability control (AutoRead)**

Check in water vapor-saturated air.

To carry out the FDO® Check, use the check and storage vessel FDO® Check.

During the FDO® Check the Stability control function (AutoRead) is automatically activated.

Proceed as follows to carry out the FDO® Check:

1. Connect the D.O. sensor to the meter.
2. Place the D.O. sensor in the FDO® Check check and storage vessel.



The sponge in the check and storage vessel must be moist (not wet). Leave the sensor in the check and storage vessel long enough so it can adapt to the ambient temperature (min. 15 minutes).

3. In the measuring mode, use *FDO Check / Start FDO Check* to start the FDO® Check.  
The meter switches to the display of %.function is automatically activated.

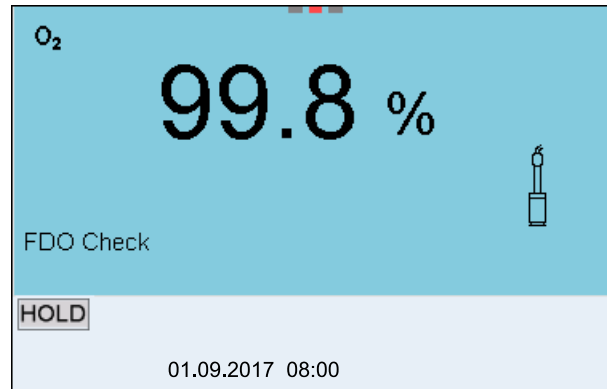

4. Start the measurement with **<ENTER>**.  
The measured value is checked for stability (stability control).  
The [AR] status indicator is displayed. The measured parameter flashes.
5. Wait for the end of the AutoRead measurement ([HOLD][AR]) status indicator or  
take over the measured value with **<ENTER>**.  
The measured value is frozen.
6. Switch to the measured value display with **<M>**.  
The check measurement is not documented.

#### 8.2.4 Evaluation

The evaluation is based on the accuracy required by the used. Together with the nominal value (100 %) this results in a validity scope for the check.

If the measured value is within the validity scope, no cleaning or user calibration is required.

If the measured value is outside the validity scope, the sensor shaft and membrane should be cleaned, and the check should then be repeated (see section 5.4.1).

Example:

- Required accuracy:  $\pm 2$  %.
- In water vapor-saturated air or in air-saturated water, the nominal value is 100 % (while taking into account the local air pressure).
- Therefore, the validity scope is 98 ... 102 %
- The check resulted in a measured value of 99.3 %

The measurement error is within the specified validity scope.  
No cleaning or user calibration is required.

## 8.3 Calibration

### 8.3.1 Why calibrate?

D.O. sensors age. This changes the slope of the D.O. sensor. Calibration determines the current slope of the sensor and stores this value in the instrument.



The FDO® 925 D.O. sensor ages so little it does not have to be regularly calibrated.

To detect changes of the sensor as early as possible, the FDO® Check procedure can be useful (see section 8.2 FDO® CHECK (CHECKING THE FDO 925), page 73).

### 8.3.2 When to calibrate?

- If your evaluation of the FDO® Check suggests calibrating
- When the calibration interval has expired
- When your accuracy requirements are especially high
- Routinely within the framework of the company quality assurance
- After a *Zero calibration*.

### 8.3.3 Calibration procedures

The Multi 9620 IDS provides 2 calibration procedures:

- Calibration in water vapor-saturated air.
- Calibration via a comparison measurement (e.g. Winkler titration according to DIN EN 25813 or ISO 5813). At the same time, the relative slope is adapted to the comparison measurement by a correction factor. When the correction factor is active, the [*Factor*] indicator appears in the measuring window.

### 8.3.4 Calibration in water vapor-saturated air

For this calibration procedure, the *Comparison meas.* setting must be set to *off* in the *Calibration* menu.

Proceed as follows to calibrate the D.O. sensor:

1. Connect the D.O. sensor to the meter.
2. Place the D.O. sensor FDO® 925 in the check and storage vessel FDO® Check .



The sponge in the check and storage beaker must be moist (not wet). Leave the sensor in the check and storage vessel long enough so it can adapt to the ambient temperature (min. 15 minutes).

3. Start the calibration with **<CAL>**.  
The last calibration data (relative slope) is displayed.

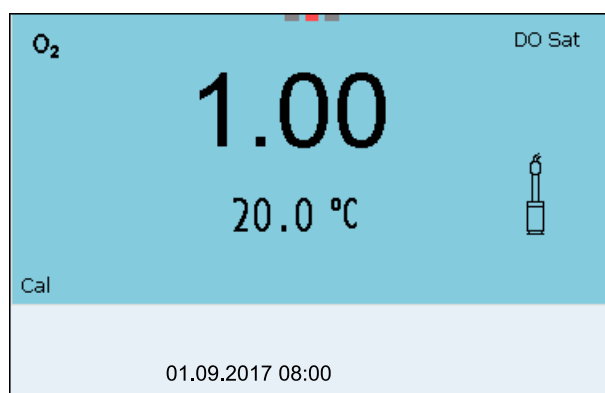

4. Start the measurement with **<ENTER>**.  
The measured value is checked for stability (stability control).  
The [AR] status indicator is displayed. The measured parameter flashes.
5. Wait for the end of the AutoRead measurement.  
The calibration record is displayed and output to the interface.
6. Switch to the measured value display with **<ENTER>**.

### 8.3.5 Calibration via a *Comparison meas.*

With the calibration procedure *Comparison meas.*, the measured value of the sensor is adjusted to the nominal value of a comparison solution via a correction factor. The current correction factor is documented in the sensor menu (**i** *Factor* = x.xxx) and in the calibration record.

For this calibration procedure, the *Comparison meas.* setting must be set to *on* in the *Calibration* menu.

Proceed as follows to calibrate the :

1. Connect the D.O. sensor to the meter.
2. Immerse the D.O. sensor in the reference solution.
3. Start the calibration with **<CAL>**.

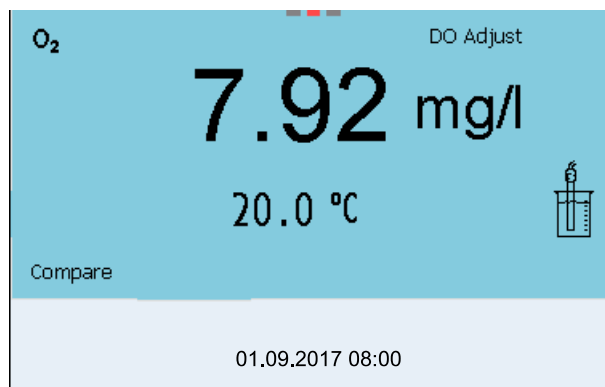

4. Start the measurement with **<ENTER>**.  
The measured value is checked for stability (stability control).  
The [AR] status indicator is displayed. The measured parameter flashes.
5. Wait for the end of the AutoRead measurement.  
The factor that was set last is displayed.

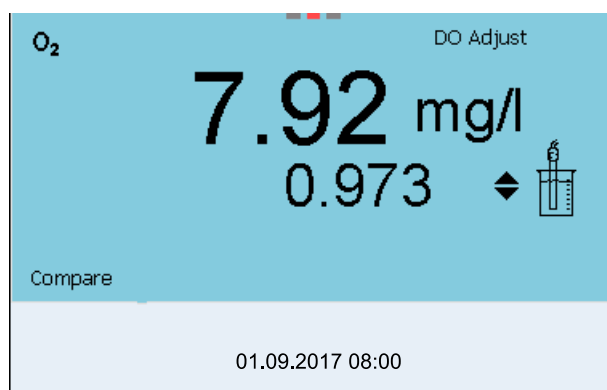

6. Using **<▲>** **<▼>**, set the correction factor to adjust the displayed concentration value to the nominal value (value of the comparison measurement). Subsequently, accept the correction factor with **<ENTER>**.  
The meter switches to the measured value display.  
The status display [*Factor*] is active.

### 8.3.6 Calibration data



The calibration record is automatically transmitted to the interface after calibrating.

**Displaying the calibration record**

The calibration record of the last calibration is available in the menu *Calibration / Calibration record*. To open it in the measured value display, press the **<CAL\_>** key.

The calibration records of the last 10 calibrations are available in the menu *Calibration / Calibration data storage / Display*. To open the *Calibration* menu in the measured value display, press the **<ENTER>** key.

Menu item	Setting/function	Explanation
<i>Calibration / Calibration data storage / Display</i>	-	Displays the calibration records. Further options: <ul style="list-style-type: none"> <li>● Scroll through the calibration records with <b>&lt;&lt;&gt;&gt;</b>.</li> <li>● Using <b>&lt;PRT&gt;</b>, output the displayed calibration record to the interface USB-B (<i>USB Device</i>, e.g. PC) or USB-A (<i>USB Host</i>, e.g. USB printer).</li> <li>● Using <b>&lt;PRT_&gt;</b>, output all calibration records to the interface USB-B (<i>USB Device</i>, e.g. PC) or USB-A (<i>USB Host</i>, e.g. USB printer).</li> <li>● Quit the display with <b>&lt;ESC&gt;</b>.</li> <li>● Switch directly to the measured value display with <b>&lt;M&gt;</b>.</li> </ul>
<i>Calibration / Calibration data storage / Output to USB flash drive or printer</i>	-	Outputs the stored calibration data to the USB-A interface ( <i>USB Host</i> , e.g. USB memory device/USB printer).
<i>Calibration / Calibration data storage / Output to RS232/USB</i>	-	Outputs the stored calibration data to the USB-B interface ( <i>USB Device</i> , e.g. PC)

**Calibration evaluation**

After calibration, the meter automatically evaluates the current status of the calibration. The evaluation appears on the display and in the calibration record.





For evaluation, the characteristic curve of the sensor that was determined is compared to the characteristic curve of an ideal sensor at similar environmental conditions (relative slope S):

$$S = S_{\text{sensor}} / S_{\text{ideal sensor}}$$

An ideal sensor has a slope of 1.

**Calibration evaluation  
FDO® 925**

Display	Calibration record	Relative slope
	+++	S = 0.94 ... 1.06
	++	S = 0.92 ... 0.94 or S = 1.06 ... 1.08
	+	S = 0.90 ... 0.92 or S = 1.08 ... 1.10
<i>Error</i> Error elimination (see section 15 WHAT TO DO IF..., page 125)	<i>Error</i>	S < 0.90 or S > 1.10

**Calibration record**

```

CALIBRATION Ox
01.09.2017 07:43:33

FDO® 925
Ser. no. 10146858

SC-FDO 925                10158765
Relative slope            0.98
Sensor                    +++
    
```

## 9 Conductivity

### 9.1 Measuring

#### 9.1.1 Measuring the conductivity



The sensor connection and the USB-B (*USB Device*) interface are galvanically insulated. This facilitates interference-free measurements also in the following cases:

- Measurement in grounded test samples
- Measurement with several sensors connected to one Multi 9620 IDS in one test sample

1. Connect the conductivity sensor to the meter. The conductivity measuring window is displayed. The measuring cell and cell constant for the connected IDS conductivity sensor are automatically taken over.
2. If necessary, press **<M>** to select the measured parameter  $\chi$ .
3. Immerse the conductivity sensor in the test sample.

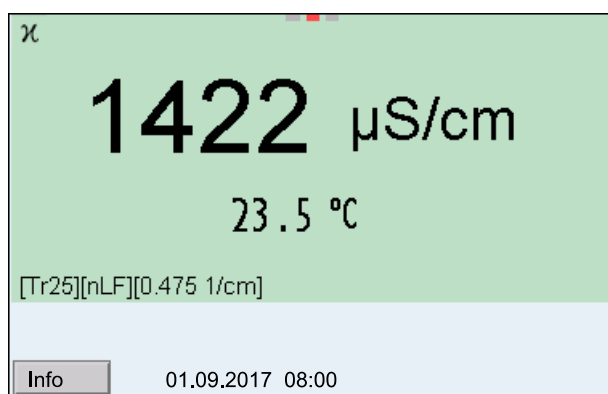

#### Selecting the displayed measured parameter

You can switch between the following displays with **<M>**:

- Conductivity [ $\mu\text{S}/\text{cm}$ ] / [ $\text{mS}/\text{cm}$ ]
- Resistivity [ $\Omega\cdot\text{cm}$ ] / [ $\text{k}\Omega\cdot\text{cm}$ ] / [ $\text{M}\Omega\cdot\text{cm}$ ]
- Salinity Sal [ ]
- Total dissolved solids TDS [ $\text{mg}/\text{l}$ ] / [ $\text{g}/\text{l}$ ]

The factor to calculate the total dissolved solids is set to 1.00 in the factory. You can adjust this factor to meet your requirements in the range 0.40 ... 1.00. The factor is set in the menu for the parameter TDS.

#### Stability control (AutoRead) & HOLD function

The stability control function (*AutoRead*) continually checks the stability of the measurement signal. The stability has a considerable impact on the reproducibility of measured values.

The measured parameter flashes on the display

- as soon as the measured value is outside the stability range
- when the automatic *Stability control* is switched off.



You can start the *Stability control* manually at any time, irrespective of the setting for automatic *Stability control* (see section 11.7.3 AUTOMATIC STABILITY CONTROL, page 107) in the *System* menu.

1. Freeze the measured value with **<AR>**.  
The [HOLD] status indicator is displayed.  
The HOLD function is active.



You can terminate the *Stability control* function and the HOLD function with **<AR>** or **<M>** at any time.

2. Using **<ENTER>**, activate the *Stability control* function manually.  
The [AR] status indicator appears while the measured value is assessed as not stable. A progress bar is displayed and the display of the measured parameter flashes.  
As soon as a measured value meets the stability criteria, it is frozen. The [HOLD][AR] status indicator is displayed, the progress bar disappears and the display of the measured parameter stops flashing.  
The current measurement data is output to the interface. Measurement data meeting the stability control criterion is marked by AR.



You can prematurely terminate the *Stability control* function manually with **<ENTER>** at any time. If the *Stability control* function is prematurely terminated, the current measurement data are output to the interfaces USB-B (*USB Device*, e.g. PC) and USB-A (*USB Host*, e.g. USB memory device or USB printer) without AutoRead info.

3. Using **<ENTER>**, start a further measurement with stability control.  
or  
Release the frozen measured value again with **<AR>** or **<M>**.  
The [AR] status display disappears. The display switches back to the previous indication.

#### Criteria for a stable measured value

The *Stability control* function checks whether the measured values are stable within the monitored time interval.

Measured parameter	Time interval	Stability in the time interval
Conductivity $\chi$	10 seconds	$\Delta \chi$ : better than 1.0% of measured value
Temperature	15 seconds	$\Delta$ : better than 0.5 °C

The minimum duration until a measured value is assessed as stable is the monitored time interval. The actual duration is mostly longer.

### 9.1.2 Measuring the temperature

For reproducible conductivity measurements, it is essential to measure the temperature of the test sample.

IDS sensors measure the temperature with a temperature sensor integrated in the IDS sensor.

## 9.2 Temperature compensation

The calculation of the temperature compensation is based on the preset reference temperature, 20 °C or 25 °C. It appears on the display as *Tr20* or *Tr25*.

You can select one of the following temperature compensation methods:

- **Nonlinear temperature compensation (*nLF*)** according to ISO 7888
- **Linear temperature compensation (*Lin*)** with adjustable coefficient
- **No temperature compensation (*off*)**



The reference temperature and temperature compensation are set in the menu for the parameter, conductivity (see section 11.5.1 SETTINGS FOR IDS CONDUCTIVITY SENSORS, page 102).

### Application tips

Select the following temperature compensations given in the table according to the respective test sample:

Test sample	Temperature compensation	Display
Natural water (ground water, surface water, drinking water)	<i>nLF</i> according to ISO 7888	<i>nLF</i>
Ultrapure water	<i>nLF</i> according to ISO 7888	<i>nLF</i>
Other aqueous solutions	<i>lin</i> Set linear temperature coefficient 0.000 ... 10.000 %/K	<i>lin</i>
Salinity (seawater)	Automatic <i>nLF</i> according to IOT (International Oceanographic Tables)	<i>Sal, nLF</i>

## 9.3 Calibration

### 9.3.1 Why calibrate?

Aging slightly changes the cell constant, e.g. due to coatings. As a result, an inexact measured value is displayed. The original characteristics of the cell can often be restored by cleaning the cell. Calibration determines the current value of the cell constant and stores this value in the meter.

Thus, you should calibrate at regular intervals.

### 9.3.2 When to calibrate?

- After connecting a sensor
- Routinely within the framework of the company quality assurance
- When the cleaning interval has expired

### 9.3.3 Determining the cell constant (calibration in control standard)

You can determine the actual cell constant of the IDS conductivity sensor by calibrating with the control standard in the following range:

- 0.450 ... 0.500  $\text{cm}^{-1}$   
(e.g. TetraCon 925, nominal cell constant 0.475  $\text{cm}^{-1}$ )

The cell constant is determined in the control standard, 0.01 mol/l KCl.

In the default condition, the calibrated cell constant of the IDS sensor is set to 0.475  $\text{cm}^{-1}$  (IDS conductivity sensor TetraCon 925).

For this calibration procedure, the *Type* setting must be set to *cal*. Proceed as follows to determine the cell constant:

1. Connect the conductivity sensor to the meter.
2. In the measured value display, select the conductivity parameter with **<M>**.
3. Start the calibration with **<CAL>**.  
The cell constant that was calibrated last is displayed.

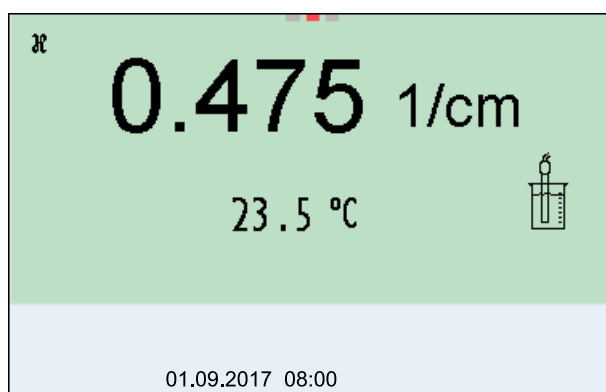

4. Immerse the conductivity sensor in the control standard solution, 0.01 mol/l KCl.
5. Start the measurement with **<ENTER>**.  
The measured value is checked for stability (stability control).  
The [AR] status indicator is displayed. The measured parameter flashes.
6. Wait for the end of the measurement with stability control or accept the calibration value with **<ENTER>**.  
The calibration record is displayed and output to the interface.
7. Switch to the measured value display with **<ENTER>**.

### 9.3.4 Calibration data



The calibration record is automatically transmitted to the interface after calibrating.

The calibration data can be displayed and then output to the interface.

#### Displaying the calibration record

The calibration record of the last calibration is available in the menu *Calibration / Calibration record*. To open it in the measured value display, press the **<CAL\_>** key.

The calibration records of the last 10 calibrations are available in the menu *Calibration / Calibration data storage / Display*. To open the *Calibration* menu in the measured value display, press the **<ENTER>** key.

Menu item	Setting/function	Explanation
<i>Calibration / Calibration data storage / Display</i>	-	Displays the calibration records.  Further options: <ul style="list-style-type: none"> <li>● Scroll through the calibration records with <b>&lt;&lt;&lt;&gt;&gt;&gt;</b>.</li> <li>● Using <b>&lt;PRT&gt;</b>, output the displayed calibration record to the interface USB-B (<i>USB Device</i>, e.g. PC) or USB-A (<i>USB Host</i>, e.g. USB printer).</li> <li>● Using <b>&lt;PRT_&gt;</b>, output all calibration records to the interface USB-B (<i>USB Device</i>, e.g. PC) or USB-A (<i>USB Host</i>, e.g. USB printer).</li> <li>● Quit the display with <b>&lt;ESC&gt;</b>.</li> <li>● Switch directly to the measured value display with <b>&lt;M&gt;</b>.</li> </ul>
<i>Calibration / Calibration data storage / Output to USB flash drive or printer</i>	-	Outputs the stored calibration data to the USB-A interface ( <i>USB Host</i> , e.g. USB memory device/USB printer).
<i>Calibration / Calibration data storage / Output to RS232/USB</i>	-	Outputs the stored calibration data to the USB-B interface ( <i>USB Device</i> , e.g. PC)

**Calibration evaluation**

After calibration, the meter automatically evaluates the current status of the calibration. The evaluation appears on the display and in the calibration record.

Display	Calibration record	Cell constant [ $\text{cm}^{-1}$ ]
	+++	Within the range 0.450 ... 0.500 $\text{cm}^{-1}$
<i>Error</i> Error elimination (see section 15 WHAT TO DO IF..., page 125)	<i>Error</i>	Outside the range 0.450 ... 0.500 $\text{cm}^{-1}$

**Calibration record (example)**

```

CALIBRATION Cond
01.09.2017 07:43:33

TetraCon 925
Ser. no. 09250033

Cell constant           0.476 1/cm
25.0 °C
Sensor                 +++
  
```

## 10 Turbidity measurement (VisoTurb® 900-P)

### 10.1 Measuring

#### 10.1.1 Measuring the turbidity



The sensor connection and the USB-B (*USB Device*) interface are galvanically insulated. This facilitates interference-free measurements also in the following cases:

- Measurement in grounded test samples
- Measurement with several sensors connected to one Multi 9620 IDS in one test sample

#### Preparatory activities

Perform the following preparatory activities when you want to measure:

- Avoid gas bubbles (e.g. air bubbles) in the test sample.
  - Use suitable vessels for measurement and calibration (see operating manual of the VisoTurb® 900-P sensor).
  - Heed the minimum depth of immersion for the sensor
1. Connect a turbidity sensor to the measuring instrument. The turbidity measuring screen is displayed. The data for the connected IDS turbidity sensor are automatically taken over.
  2. Fill the test sample into a lightproof measuring beaker up to a level of at least 6 cm.
  3. When immersing the sensor in the test sample, hold the sensor at an angle.
  4. For measuring, position the sensor upright.
  5. Position the sensor in a way that meets the following requirements.
    - Distance to the bottom: 6 cm
    - Distance to the walls of the beaker: 2 cm
    - Minimum depth of immersion: 2 cm



To position the sensor optimally and permanently while it is measuring, fix it on a support.

#### Measuring

You can carry out turbidity measurements as follows:

1. Perform the preparatory activities.
2. Immerse the sensor in the test sample at an angle and then position it in the measuring container.

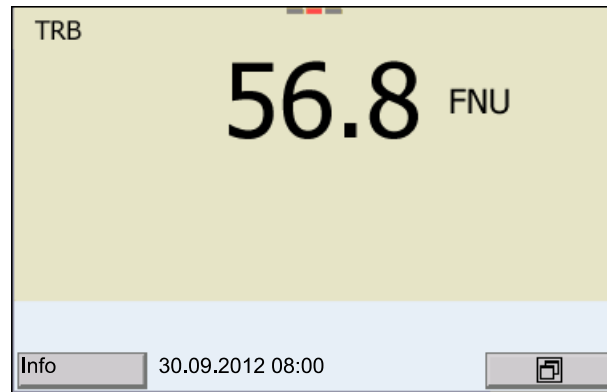

### Selecting the displayed measured parameter

You can switch between the following displays with **<M>**:

- Turbidity [FNU]
- Turbidity [NTU]

### Freezes the measured value (HOLD function)

With the HOLD function, you can freeze the current measured value. The displayed measured value stops changing until you switch the HOLD function off.

1. Freeze the measured value with **<AR>**. The [HOLD] status indicator is displayed.



If the HOLD function is active, you can, e.g. start a manual measurement with stability control.

2. Release the frozen measured value again with **<AR>**. The HOLD function is switched off. The [HOLD] status display disappears.

### Stability control (AutoRead)

The stability control function (*AutoRead*) continually checks the stability of the measurement signal. The stability has a considerable impact on the reproducibility of measured values. The display of the measured parameter flashes until a stable measured value is available.

You can start the *Stability control* manually at any time, irrespective of the setting for automatic *Stability control* (see section 11.7.3 AUTOMATIC STABILITY CONTROL, page 107) in the *System* menu.

1. Freeze the measured value with **<AR>**. The [HOLD] status indicator is displayed.
2. Using **<ENTER>**, activate the *Stability control* function manually. The [AR] status indicator appears while the measured value is assessed as not stable. A progress bar is displayed and the display of the measured parameter flashes. The [HOLD][AR] status indicator appears as soon as a stable measured value is recognized. The progress bar disappears and the display of the measured parameter stops flashing. The current measurement data is output to the interface. Measurement data meeting the stability control criterion is marked by AR.



You can prematurely terminate the *Stability control* function manually with **<ENTER>** at any time. If the *Stability control* function is prematurely terminated, the current measurement data are output to the interface without the AutoRead info.

3. Using **<ENTER>**, start a further measurement with *Stability control*.  
or  
Release the frozen measured value again with **<AR>**.  
The display switches to the measured value display.  
The [AR][HOLD] status display disappears.

### Criteria for a stable measured value

The *Stability control* function checks whether the measured values are stable within the monitored time interval.

Measured parameter	Time interval	Stability in the time interval
Turbidity (FNU/NTU)	15 seconds	$\Delta$ : better than 1.0% of measured value

The minimum duration until a measured value is assessed as stable is the monitored time interval. The actual duration is mostly longer.

## 10.2 Calibration

### 10.2.1 Why calibrate?

The calibration line of the sensor is determined and stored through calibrating.

### 10.2.2 When to calibrate?

- When the calibration interval has expired
- At regular intervals

### 10.2.3 Calibration standards

Calibrate with 1 to 3 turbidity standard solutions. The standard solutions must be selected in the following order.

Standard solution	Range (FNU/NTU)
1	0.0 ... 1.0
2	5.0 ... 200.0
3	200.0 ... 4000.0

The turbidity expected in the measurement dictates the number and selection of the standards. Calibration has to be carried out for the range with the highest



turbidity to be expected and for all lower ranges. The standard solutions for this have to be selected in ascending order, starting with standard 1.

**Example:** If you expect turbidity values in the range 200 ... 4000 FNU/NTU, you have to carry out a 3-point calibration.

The measurement precision is also dependent on the selected standard solutions. Therefore, the selected standard solutions should cover the value range expected of the turbidity measurement.

If the measured turbidity is outside the measurement range, OFL is displayed.



As the standard with turbidity value 0.0 FNU you can use clean tap water or filtered, deionized water in a suitable calibration vessel, depending on the required quality (see operating manual of the sensor VisoTurb® 900-P). This standard should be freshly prepared prior to every calibration. Suitable bottles are listed in the price list of the WTW catalog "Lab and field instrumentation".

Standards with turbidity values for the calibration ranges 2 and 3 are available as accessories (see price list of the WTW catalog "Lab and field instrumentation"). Calibration can be carried out in the bottles the standards are delivered in. The standards can be used several times within their shelf life.

Replace the standards solutions if you have any doubts concerning their quality or after the expiration date.

#### 10.2.4 Carry out calibration

1. Perform the preparatory activities.
2. Connect the turbidity sensor to the measuring instrument.  
The turbidity measuring screen is displayed.
3. Keep the standard solutions ready in suitable calibration vessels.
4. In the measured value display, select the TRB measuring window with **<▲>** **<▼>** and **<M>**.
5. Start the calibration with **<CAL>**.  
The calibration display appears.

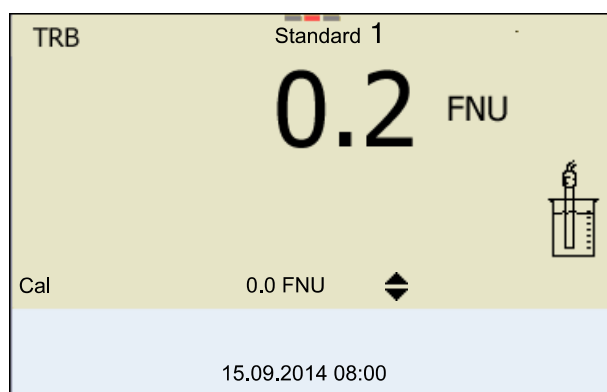

6. Thoroughly rinse the turbidity sensor with distilled water and dry it with a lint-free cloth.
7. Immerse the turbidity sensor in the test sample at an angle.
8. Position the turbidity sensor in the measuring vessel.
9. Use <▲> <▼> and <◀><▶> to set the concentration of the standard solution for each digit and confirm with <ENTER>. The standard solution is measured. The measured value is checked for stability (AutoRead).
10. Wait for the end of the AutoRead measurement. The calibration display for the next standard solution appears.

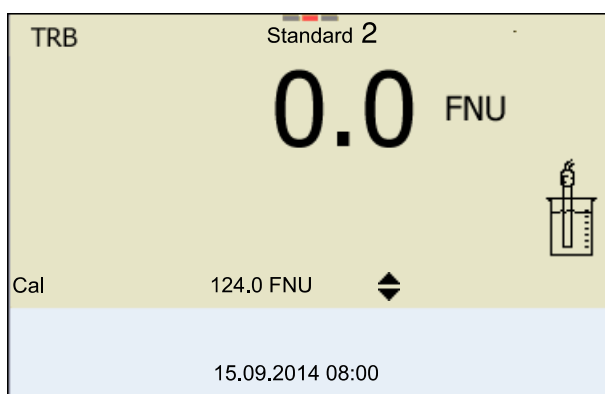

**Continuing with two-point calibration**

11. Thoroughly rinse the turbidity sensor with distilled water and dry it with a lint-free cloth.
12. Immerse the turbidity sensor in the test sample at an angle.
13. Position the turbidity sensor in the measuring vessel.
14. Use <▲> <▼> and <◀><▶> to set the concentration of the standard solution for each digit and confirm with <ENTER>. The standard solution is measured. The measured value is checked for stability (AutoRead).
15. Wait for the end of the AutoRead measurement. The calibration display for the next standard solution appears.



16. If necessary, terminate the calibration as a two-point calibration with **<M>**.  
The new calibration values are displayed.  
or  
Continue with three-point calibration.

**Continuing with three-point calibration**

Repeat the steps 11 to 15 with the third standard solution. The new calibration values are displayed after the last calibration step was completed.

**10.2.5 Calibration data**

**Displays the calibration data**



*Calibration* The calibration protocol of the last calibration is available in the menu **<ENTER>** / *Calibration record*. To open it in the measured value display, press the **<CAL\_>** key.

The calibration records of the last 10 calibrations are available in the menu *Calibration / Calibration data storage / Display*. To open the *Calibration* menu in the measured value display, press the **<ENTER>** key.

Menu item	Setting/function	Explanation
<i>Calibration / Calibration data storage / Display</i>	-	Displays the calibration record.  Further options: <ul style="list-style-type: none"> <li>● Scroll through the calibration records with <b>&lt;&lt;&gt;&gt;</b>.</li> <li>● Output the displayed calibration record to the interface with <b>&lt;PRT&gt;</b>.</li> <li>● Output all calibration records to the interface with <b>&lt;PRT_&gt;</b>.</li> <li>● Quit the display with <b>&lt;ESC&gt;</b> or <b>&lt;ENTER&gt;</b>.</li> <li>● Switch directly to the measured value display with <b>&lt;M&gt;</b>.</li> </ul>
<i>Calibration / Calibration data storage / Output to RS232/USB</i>	-	Outputs the calibration records to the interface USB-B ( <i>USB Device</i> ).

**Calibration evaluation**

After calibrating, the meter automatically evaluates the calibration.

Display	Calibration record	Explanation
	+++	Optimum calibration
		Good calibration

**Calibration record  
(USB output)**

```

Multi 9620 IDS
Ser. no. 12345678

CALIBRATION TRB:
VisoTurb 900-P
Ser. no. 14E999003
18.09.2014 08:09:10

# 1                0.0 FNU
# 2                124.0 FNU
Sensor            +++
    
```

# 11 Settings

## 11.1 pH measurement settings

### 11.1.1 Settings for pH measurements

The settings are made in the menu for calibration and measurement settings of the pH/ORP measurement. To open the settings, display the required measured parameter in the measured value display and press the **<ENTER>** key. After completing the settings, switch to the measured value display with **<M>**. Default settings are printed in **bold**.

Menu item	Possible setting	Explanation
<i>Calibration / Calibration record</i>	-	Displays the calibration record of the last calibration.
<i>Calibration / Calibration data storage / Display</i>	-	Displays the last calibration records (max. 10)
<i>Calibration / Calibration data storage / Output to RS232/USB</i>	-	Outputs the stored calibration data to the USB-B interface (USB Device, e.g. PC)
<i>Calibration / Calibration data storage / Output to USB flash drive or printer</i>	-	Outputs the stored calibration data to the USB-A interface (USB Host, e.g. USB memory device/USB printer).
<i>Calibration / Buffer</i>	<b>TEC</b> <i>ConCal</i> <i>NIST/DIN</i> ...	Buffer sets to be used for pH calibration. More buffers and details: see section 11.1.2 BUFFER SETS FOR CALIBRATION, page 95 and section 5.2 PH CALIBRATION, page 29.
<i>Calibration / Single-point calibration</i>	<i>yes</i> <b>no</b>	Quick calibration with 1 buffer
<i>Calibration / Calibration interval</i>	<i>1 ... 7 ... 999</i> <i>d</i>	<i>Calibration interval</i> for the IDS pH sensor (in days). The meter reminds you to calibrate regularly by the flashing sensor symbol in the measuring screen.
<i>Calibration / Unit for slope</i>	<b>mV/pH</b> <b>%</b>	Unit of the slope. The % display refers to the Nernst slope of -59.2 mV/pH (100 x determined slope/Nernst slope).
<i>QSC / First calibration</i>	-	Starts the initial calibration with QSC buffers. This menu item is only available as long as no initial calibration was carried out with the connected IDS sensor.
<i>QSC / Record of first calibration</i>	-	Displays the calibration record of the QSC initial calibration.
<i>QSC / Control calibration</i>	-	Starts the control calibration with QSC buffers. This menu item is only available if an initial calibration was carried out with the connected IDS sensor.

Menu item	Possible setting	Explanation
<i>Alternative temperature</i>	<i>on</i> <i>off</i>	Takes over the temperature value from an IDS sensor. This menu item is only available if an IDS adapter and an IDS sensor with integrated temperature sensor are connected.
<i>Man. temperature</i>	-25... <b>+25</b> ... +130 °C	Entry of the manually determined temperature. This menu item is only available if an IDS adapter is connected.
<i>pH resolution</i>	<b>0.001</b> 0.01 0.1	Resolution of the pH display
<i>mV resolution</i>	<b>0.1</b> 1	Resolution of the mV display
<i>Limit monitoring</i>		With the <i>Limit monitoring</i> function you define the measured values whose exceeding is signaled. An acoustic signal sounds, and at the same time a message is output to the USB interface. You can switch on or off the acoustic signal in the <i>System</i> menu (see section 11.7.1 SYSTEM, page 105).
<i>Limit monitoring/ pH monitoring</i>	<i>on</i> <i>off</i>	Switch on or off the limit signaling device for the pH value.
<i>Limit monitoring/ TP monitoring</i>	<i>on</i> <i>off</i>	Switch on or off the limit signaling device for the temperature value.
<i>Limit monitoring/ pH monitoring/on/ pH upper limit</i>	-2 ... 20	Upper range limit. If it is exceeded, a message is output to the interface USB-B ( <i>USB Device</i> , e.g. PC) or USB-A ( <i>USB Host</i> , e.g. USB printer). This menu item is only visible when the <i>pH monitoring</i> setting is active.
<i>Limit monitoring/ pH monitoring/on/ pH lower limit</i>	-2 ... 20	Lower range limit. If it is exceeded, a message is output to the interface USB-B ( <i>USB Device</i> , e.g. PC) or USB-A ( <i>USB Host</i> , e.g. USB printer). This menu item is only visible when the <i>pH monitoring</i> setting is active.
<i>Limit monitoring/ TP monitoring/on/ TP upper limit</i>	-5 ... +105 °C	Upper range limit. If it is exceeded, a message is output to the interface USB-B ( <i>USB Device</i> , e.g. PC) or USB-A ( <i>USB Host</i> , e.g. USB printer). This menu item is only visible when the <i>TP monitoring</i> setting is active.

Menu item	Possible setting	Explanation
<i>Limit monitoring/ TP monitoring/on/ TP lower limit</i>	-5 ... 105 °C	Lower range limit. If it is exceeded, a message is output to the interface USB-B ( <i>USB Device</i> , e.g. PC) or USB-A ( <i>USB Host</i> , e.g. USB printer). This menu item is only visible when the <i>TP monitoring</i> setting is active.
<i>Reset</i>	-	Resets all sensor settings to the delivery condition (see section 11.8.1 RESETTING THE MEASUREMENT SETTINGS, page 108).

### 11.1.2 Buffer sets for calibration

You can use the buffer sets quoted in the table for an automatic calibration. The pH values are valid for the specified temperature values. The temperature dependence of the pH values is taken into consideration during calibration.

No.	Buffer set *	pH values	at
1	ConCal	Any	Any
2	<i>NIST/DIN</i> DIN buffers according to DIN 19266 and NIST Traceable Buffers	1.679 4.006 6.865 9.180 12.454	25 °C
3	<i>TEC</i> WTW Technical buffers	2.000 4.010 7.000 10.011	25 °C
4	<i>Merck 1*</i>	4.000 7.000 9.000	20°C
5	<i>Merck 2*</i>	1.000 6.000 8.000 13.000	20°C
6	<i>Merck 3*</i>	4.660 6.880 9.220	20°C
7	<i>Merck 4*</i>	2.000 4.000 7.000 10.000	20°C
8	<i>Merck 5*</i>	4.010 7.000 10.000	25 °C

No.	Buffer set *	pH values	at
9	<i>DIN 19267</i>	1.090 4.650 6.790 9.230	25 °C
10	<i>Mettler Toledo USA *</i>	1.679 4.003 7.002 10.013	25 °C
11	<i>Mettler Toledo EU *</i>	1.995 4.005 7.002 9.208	25 °C
12	<i>Fisher *</i>	2.007 4.002 7.004 10.002	25 °C
13	<i>Fluka BS *</i>	4.006 6.984 8.957	25 °C
14	<i>Radiometer *</i>	1.678 4.005 7.000 9.180	25 °C
15	<i>Baker *</i>	4.006 6.991 10.008	25 °C
16	<i>Metrohm *</i>	3.996 7.003 8.999	25 °C
17	<i>Beckman *</i>	4.005 7.005 10.013	25 °C
18	<i>Hamilton Duracal *</i>	4.005 7.002 10.013	25 °C
19	<i>Precisa *</i>	3.996 7.003 8.999	25 °C
20	<i>Reagecon TEC *</i>	2.000 4.010 7.000 10.000	25 °C



No.	Buffer set *	pH values	at
21	<i>Reagecon 20</i> *	2.000 4.000 7.000 10.000 13.000	20°C
22	<i>Reagecon 25</i> *	2.000 4.000 7.000 10.000 13.000	25 °C
23	<i>Chemsolute</i> *	2.000 4.000 7.000 10.000	20°C
24	<i>USABlueBook</i> *	4.000 7.000 10.000	25 °C
25	*	4.000 7.000 10.000	25 °C

Brand names or trade names are trademarks of their respective owners protected by law.



The buffers are selected in the menu, pH / **<ENTER>** / *Calibration / Buffer* (see section 11.1.1 SETTINGS FOR PH MEASUREMENTS, page 93).

### 11.1.3 Calibration interval

The calibration evaluation is displayed as a sensor symbol.

After the QSC function has been enabled the sensor symbol is replaced by the QSC scale (see section 5.2.8 QSC FUNCTION (SENSOR QUALITY CONTROL), page 40).

After the specified calibration interval has expired the sensor symbol or the QSC scale flashes. It is still possible to measure.



To ensure the high measuring accuracy of the measuring system, calibrate after the calibration interval has expired.

#### Setting the calibration interval

The calibration interval is set to 7 days in the factory.

You can change the interval (1 ... 999 days):

1. Open the menu for measurement settings with **<ENTER>**.
2. In the *Calibration / Calibration interval* menu, set the calibration interval with **<▲><▼>**.
3. Confirm the setting with **<ENTER>**.
4. Quit the menu with **<M>**.

## 11.2 ORP measurement settings

**Settings** The settings are made in the menu for measuring settings of the ORP measurement. To open the settings, display the required measured parameter in the measured value display and press the **<ENTER>** key. After completing the settings, switch to the measured value display with **<M>**. Default settings are printed in **bold**.

Menu item	Possible setting	Explanation
<i>mV resolution</i>	<b>0.1</b> 1	Resolution of the mV display
<i>Reset</i>	-	Resets all sensor settings to the delivery condition (see section 11.8.1 RESETTING THE MEASUREMENT SETTINGS, page 108).

## 11.3 ISE measurement settings

The settings are made in the measuring menu of the ISE measurement. To open the settings, activate the relevant measuring window in the measured value display and press the **<ENTER>** key shortly. After completing the settings, switch to the measured value display with **<M>**.

The following settings are possible for ISE measurements:

Menu item	Possible setting	Explanation
<i>Calibration / Calibration record</i>	-	Displays the calibration record of the last calibration.
<i>Calibration / Calibration data storage / Display</i>	-	Displays the last calibration records (max. 10)
<i>Calibration / Calibration data storage / Output to RS232/ USB</i>	-	Outputs the calibration records to the interface.

Menu item	Possible setting	Explanation
<i>Man. temperature</i>	-25 ... <b>+25</b> ... +130 °C	Entry of the manually determined temperature. For measurements without temperature sensor only.
<i>Alternative temperature</i>	<i>on</i> <i>off</i>	Takes over the temperature value from an IDS sensor.  This menu item is only available if an IDS adapter and an IDS sensor with integrated temperature sensor are connected.
<i>ISE setup/ AutoRead criterion</i>	<i>low</i> <i>medium</i> <i>high</i>	Selection of the AutoRead criteria (see section 7.1.1 MEASURING THE ION CONCENTRATION, page 47).
<i>ISE setup/ Ion type</i>	<b>Ag</b> , Br, Ca, Cd, Cl, CN, Cu, F, I, K, Na, NO <sub>3</sub> , Pb, S, NH <sub>3</sub> , NH <sub>4</sub> , CO <sub>2</sub> , ION	Selection of the ion type to be measured.  An ion that is not included in the list can be measured with the setting, ION.
	* Measuring with the NH 500 electrode: The NH <sub>4</sub> setting is not suitable for the gas-sensitive electrode NH 500. Select the following settings: <i>Ion type "ION", Valency "-1".</i>	
<i>ISE setup/ Unit</i>	<b>mg/l</b> µmol/l mg/kg ppm %	Selection, with which unit the measurement result and calibration standards should be displayed.
<i>ISE setup/ Valency</i>	-8 ... +8	Set the valence ( <i>Valency</i> ) and molar weight ( <i>Molar mass</i> ) for the ion
<i>ISE setup/ Molar mass</i>	1 ... 300 g/mol	(only for <i>ISE setup/Ion type</i> = ION)
<i>ISE setup/ Density</i>	0.001 ... 9.999 g/ml or kg/l	Adjustable density of the test sample (only with <i>Unit</i> : mg/kg, ppm, %)
<i>Method</i>	<i>Standard addition</i> <i>Standard subtraction</i> <i>Sample addition</i> <i>Sample subtraction</i> <i>Blank value addition</i>	Selection of the available measuring methods.
<i>Start method</i>		Start measurement with the selected method.



## 11.4 D.O. measurement settings

### 11.4.1 Settings for D.O. measurement

The settings are available in the menu for measurement and calibration settings. To open the settings, display the required measured parameter in the measured value display and press the **<ENTER>** key. After completing the settings, switch to the measured value display with **<M>**.

Menu item	Possible setting	Explanation
<i>Calibration / Calibration record</i>	-	Displays the calibration record of the last calibration.
<i>Calibration / Calibration data storage / Display</i>	-	Displays the last calibration records (max. 10)
<i>Calibration / Calibration data storage / Output to USB flash drive or printer</i>	-	Outputs the stored calibration data to the USB-A interface ( <i>USB Host</i> , e.g. USB memory device/USB printer).
<i>Calibration / Calibration data storage / Output to RS232/USB</i>	-	Outputs the stored calibration data to the USB-B interface ( <i>USB Device</i> , e.g. PC)
<i>Calibration / Calibration interval</i>	1 ... <b>180</b> ... 999 d	<i>Calibration interval</i> for the D.O. sensor (in days). The meter reminds you to calibrate regularly by the flashing sensor symbol in the measuring screen.
<i>FDO Check / Start FDO Check (only for FDO FDO® 925)</i>	-	Starts the check with the FDO® Check
<i>FDO Check / Check interval (only for FDO FDO® 925)</i>	1 ... <b>60</b> ... 999 d	Interval for the <i>FDO Check</i> (in days). The meter reminds you to check the sensor regularly by <i>FDO Check</i> status indicator in the measuring screen.
<i>Calibration / Comparison meas.</i>	on off	Enables to adjust the measured value with the aid of a comparison measurement, e.g. Winkler titration. For details, see section 8.3 CALIBRATION, page 75.
<i>Salinity/Sal automatic (only for parameter mg/l)</i>	on off	Automatic salt content correction for concentration measurements. The measured salinity value is taken over by a connected conductivity sensor. This menu item is only available if an IDS conductivity sensor is connected.

Menu item	Possible setting	Explanation
<i>Salinity/Sal correction</i> (only for parameter mg/l)	<i>on</i> <i>off</i>	Manual salt content correction for concentration measurements.
<i>Salinity/Salinity</i> (only for parameter mg/l)	<b>0.0 ... 70.0</b>	Salinity or salinity equivalent for the salt content correction. This menu item is only available if the automatic salt content correction is switched off and the manual salt content correction is switched on.
<i>Response time t90</i>	<b>30 ... 300</b>	Response time of the signal filter (in seconds).  A signal filter in the sensor reduces the limits of variation of the measured value. The signal filter is characterized by the response time t90. This is the time after which 90 % of a signal change is displayed.  This menu item is only available if sensor and meter support this function. You can update the firmware of sensor and meter (see section 17 FIRMWARE UPDATE, page 136).
<i>Reset</i>	-	Resets all sensor settings to the delivery condition (see section 11.8.1 RESETTING THE MEASUREMENT SETTINGS, page 108).

## 11.5 Cond measurement settings

### 11.5.1 Settings for IDS conductivity sensors

The settings are made in the menu for the measured parameter, conductivity. To open the settings, display the required measured parameter in the measured value display and press the **<ENTER>** key. After completing the settings, switch to the measured value display with **<M>**.

The possible settings are individually displayed for each sensor. Below the setting menu is displayed for two IDS sensors (TetraCon 925, LR 925/01).

Default settings are printed in **bold**.

#### General setting menu for conductivity

Menu item	Possible setting	Explanation
<i>Calibration / Calibration record</i>	-	Displays the calibration record of the last calibration.

Menu item	Possible setting	Explanation
<i>Calibration / Calibration data storage / Display</i>	-	Displays the last calibration records (max. 10)
<i>Calibration / Calibration data storage / Output to USB flash drive or printer</i>	-	Outputs the stored calibration data to the USB-A interface ( <i>USB Host</i> , e.g. USB memory device/USB printer).
<i>Calibration / Calibration data storage / Output to RS232/USB</i>	-	Outputs the stored calibration data to the USB-B interface ( <i>USB Device</i> , e.g. PC)
<i>Calibration / Calibration interval</i>	1 ... <b>150</b> ... 999 d	<i>Calibration interval</i> for the IDS conductivity sensor (in days). The meter reminds you to calibrate regularly by the flashing sensor symbol in the measuring screen.
<i>Reset</i>	-	Resets all sensor settings to the delivery condition (see section 11.8.1 RESETTING THE MEASUREMENT SETTINGS, page 108).

**Setting menu  
TetraCon 925**

Menu item	Possible setting	Explanation
<i>Type</i>	<i>Cal</i>  <i>man</i>	Used measuring cell  Measuring cells whose cell constant is determined by calibration in the KCL control standard solution. Calibration range: 0.450 to 0.500 cm <sup>-1</sup> The currently valid cell constant is displayed in the status line.  Freely adjustable cell constant in the range 0.450 ... 0.500 cm <sup>-1</sup> .
<i>Man. cell const.</i>	0.450 ... <b>0.475</b> ... 0.500 cm <sup>-1</sup>	Display and setting options for the manually adjustable cell constant. This menu item is only available when <i>Type man</i> is set.
<i>Temp. comp. (TC) / Method</i>	<i>nLF</i> <i>Lin</i> <i>off</i>	Procedure for temperature compensation (see section 9.2 TEMPERATURE COMPENSATION, page 82). This setting is only available for the measured parameters, conductivity ( $\chi$ ) and resistivity ( $\rho$ ).

Menu item	Possible setting	Explanation
<i>Temp. comp. (TC) / Linear coeff.</i>	0.000 ... <b>2.000</b> ... 3.000 %/K	Coefficient of the linear temperature compensation. This menu item is only available when the linear temperature compensation is set.
<i>Temp. comp. (TC) / Reference temp.</i>	20 °C 25 °C	Reference temperature This setting is only available for the measured parameters, conductivity ( $\chi$ ) and resistivity ( $\rho$ ).
<i>Multiplier for TDS</i>	0.40 ... <b>1.00</b>	Multiplier for TDS value

Setting menu  
LR 925/01

Menu item	Possible setting	Explanation
<i>Cell constant</i>	0.090 ... .. <b>0.100</b> ... 0.110 cm <sup>-1</sup>	Display and setting options for the cell constant
<i>Temp. comp. (TC) / Method</i>	nLF Lin off	Procedure for temperature compensation (see section 9.2 TEMPERATURE COMPENSATION, page 82). This setting is only available for the measured parameters, conductivity ( $\chi$ ) and resistivity ( $\rho$ ).
<i>Temp. comp. (TC) / Linear coeff.</i>	0.000 ... <b>2.000</b> ... 3.000 %/K	Coefficient of the linear temperature compensation. This menu item is only available when the linear temperature compensation is set.
<i>Temp. comp. (TC) / Reference temp.</i>	20 °C 25 °C	Reference temperature This setting is only available for the measured parameters, conductivity ( $\chi$ ) and resistivity ( $\rho$ ).
<i>Multiplier for TDS</i>	0.40 ... <b>1.00</b>	Multiplier for TDS value

## 11.6 Turb measurement settings

### 11.6.1 Settings for turbidity sensors

The settings are made in the menu for the measured parameter, turbidity. To open the settings, display the required measured parameter in the measured value display and press the **<ENTER>** key. After completing the settings, switch to the measured value display with **<M>**.

The possible settings are individually displayed for each sensor. Default set-



tings are printed in **bold**.

### Setting menu of the VisoTurb® 900-P

Menu item	Possible setting	Explanation
<i>Calibration / Calibration record</i>	-	Displays the calibration record of the last calibration.
<i>Calibration / Calibration data storage / Display</i>	-	Displays the last calibration records (max. 10)
<i>Calibration / Calibration data storage / Output to USB flash drive or printer</i>	-	Outputs the stored calibration data to the USB-A interface ( <i>USB Host</i> , e.g. USB memory device/USB printer).
<i>Calibration / Calibration data storage / Output to RS232/USB</i>	-	Outputs the stored calibration data to the USB-B interface ( <i>USB Device</i> , e.g. PC)
<i>Calibration / Calibration interval</i>	<b>1 ... 30 ... 999 d</b>	<i>Calibration interval</i> for the turbidity sensor (in days). The meter reminds you to calibrate regularly by the flashing sensor symbol in the measuring screen.
<i>Resolution</i>	<b>0.1</b> 1	Resolution of the FNU/NTU display
<i>Reset</i>	-	Resets all sensor settings to the delivery condition (see section 11.8.1 RESETTING THE MEASUREMENT SETTINGS, page 108).

## 11.7 Sensor-independent settings

### 11.7.1 System

To open the *Storage & config* menu, press the **<ENTER\_>** key in the measured value display. After completing the settings, switch to the measured value display with **<M>**.

Default settings are printed in **bold**.

Menu item	Setting	Explanation
<i>System / General / Language</i>	<b>Deutsch</b> <b>English</b> (more)	Selects the menu language
<i>System / General / Audio signal</i>	<b>on</b> <b>off</b>	Switches on/off the beep on keystroke
<i>System / General / Brightness</i>	<b>0 ... 15 ... 22</b>	Changes the display brightness

Menu item	Setting	Explanation
<i>System / General / Temperature unit</i>	°C °F	Temperature unit, degrees Celsius or degrees Fahrenheit. All temperature values are displayed with the selected unit.
<i>System / General / Barometric pressure unit</i>	<b>mbar</b> mmHg inHg	Air pressure unit
<i>System / General / Stability control</i>	on off	Switches on or off the automatic stability control during measurement (see section 11.7.3 AUTOMATIC STABILITY CONTROL, page 107 )
<i>System / Interface / Baud rate</i>	1200, 2400, <b>4800</b> , 9600, 19200	Baud rate of the USB-B interface ( <i>USB Device</i> )
<i>System / Interface / Output format</i>	ASCII CSV	Output format for data transmission For details, see section 13 TRANSMITTING DATA, page 118
<i>System / Interface / Decimal separator</i>	Dot (xx.x) Comma (xx,x)	Decimal separator
<i>System / Interface / Output header</i>		Output of a header for <i>Output format: CSV</i>
<i>System / Interface / Extended Oxi output</i>		The measured values for the parameters concentration (mg/l ) and saturation (%) are output together. The function is active if the following requirements are met: <ul style="list-style-type: none"> <li>● a D.O. sensor is connected</li> <li>● The D.O. sensor displays the parameter concentration (mg/l) or saturation (%)</li> <li>● the <i>Output format CSV</i> is set</li> </ul>
<i>System / Clock function</i>	<i>Date format</i> <i>Datum</i> <i>Time</i>	Settings of time and date. For details, see section 4.5.5 EXAMPLE 2 ON NAVIGATION: SETTING THE DATE AND TIME, page 25
<i>System / Service information</i>		Hardware version and software version of the meter are displayed.
<i>System / Reset</i>	-	Resets the system settings to the default values. For details, see section 11.8.2 RESETTING THE SYSTEM SETTINGS, page 111

### 11.7.2 Data storage

This menu contains all functions to display, edit and erase stored measured values.



Detailed information on the memory functions of the Multi 9620 IDS are given in section 12 DATA STORAGE, page 112.

### 11.7.3 Automatic Stability control

The automatic *Stability control* (AutoRead) function continuously checks the stability of the measurement signal. The stability has a considerable impact on the reproducibility of measured values.

You can activate or switch off the automatic *Stability control* function (see section 11.7 SENSOR-INDEPENDENT SETTINGS, page 105).

The measured parameter flashes on the display

- as soon as the measured value is outside the stability range
- when you switch over between the measured parameters with **<M>**.
- when the automatic *Stability control* is switched off.

## 11.8 Reset

You can reset (initialize) all sensor settings and sensor-independent settings separately from each other.

### 11.8.1 Resetting the measurement settings



The calibration data are reset to the default settings together with the measuring parameters. Recalibrate after performing a reset.

**pH** The following settings for pH measurements are reset to the default settings with the *Reset* function:

Setting	Default settings
<i>Buffer</i>	<i>TEC</i>
<i>Calibration interval</i>	7 d
<i>Unit for slope</i>	mV/pH
<i>Measured parameter</i>	pH
<i>pH resolution</i>	0.001
<i>mV resolution</i>	0.1
<i>Asymmetry</i>	0 mV
<i>Slope</i>	-59.2 mV
<i>Man. temperature</i>	25 °C
<i>Single-point calibration</i>	off

The sensor settings are reset under the *Reset* menu item in the menu for calibration and measurement settings. To open the settings, display the required measured parameter in the measured value display and press the **<ENTER>** key.

**ORP** The following settings for ORP measurements are reset to the default settings with the *Reset* function:

Setting	Default settings
<i>mV resolution</i>	0.1
<i>Man. temperature</i>	25 °C

The sensor settings are reset under the *Reset* menu item in the menu for calibration and measurement settings. To open the settings, display the required measured parameter in the measured value display and press the **<ENTER>** key.

**ISE** The following settings for ISE measurements are reset to the default settings with the *Reset* function:

Setting	Default settings
<i>AutoRead criterion</i>	<i>high</i>
<i>Ion type</i>	Ag
<i>Unit</i>	mg/l
<i>Man. temperature</i>	25 °C
<i>Alternative temperature</i>	<i>off</i>
<i>Method</i>	<i>Standard addition</i>

The sensor settings are reset under the *Reset* menu item in the menu for calibration and measurement settings. To open the settings, display the required measured parameter in the measured value display and press the **<ENTER>** key.

**Dissolved oxygen** The following settings for D.O. measurements are reset to the default settings with the *Reset* function:

Setting	Default settings
<i>Calibration interval</i>	180 d
<i>Check interval</i>	60 d
<i>Measured parameter</i>	D.O. concentration (mg/l)
<i>Relative slope (<math>S_{Rel}</math>)</i>	1.00
<i>Salinity (value)</i>	0,0
<i>Salinity (function)</i>	Off
<i>Number of cal. points</i>	1
<i>Resolution</i>	0.1
<i>DO % Saturation local</i>	off

The sensor settings are reset under the *Reset* menu item in the menu for calibration and measurement settings. To open the settings, display the required measured parameter in the measured value display and press the **<ENTER>** key.

**Conductivity** The following settings for conductivity measurements are reset to the default settings with the *Reset* function:

Setting	Default settings
<i>Calibration interval</i>	150 d
<i>Measured parameter</i>	$\chi$
<i>Cell constant (c)</i>	Depending on the connected measuring cell: 0.475 cm <sup>-1</sup> (calibrated) 0.475 cm <sup>-1</sup> (set) 0.100 cm <sup>-1</sup>
<i>Temperature compensation</i>	nLF
<i>Reference temperature</i>	25 °C
<i>Temperature coefficient (TC) of the linear temperature compensation</i>	2.000 %/K
<i>TDS multiplier</i>	1.00

The sensor settings are reset under the *Reset* menu item in the menu for calibration and measurement settings. To open the settings, display the required measured parameter in the measured value display and press the **<ENTER>** key.

### 11.8.2 Resetting the system settings

The following system settings can be reset to the default status:

Setting	Default settings
<i>Language</i>	English
<i>Audio signal</i>	on
<i>Baud rate</i>	4800 Baud
<i>Output format</i>	ASCII
<i>Decimal separator</i>	Dot (xx.x)
<i>Brightness</i>	10
<i>Temperature unit</i>	°C
<i>Stability control</i>	on

The resetting of the system settings is done in the menu *Storage & config / System / Reset*. To open the menu *Storage & config* in the measured value display, press the **<ENTER\_>** key.

## 12 Data storage

You can transmit measured values (datasets) to the data storage:

- Manual data storage (see section 12.1 MANUAL STORAGE, page 112)
- Automatic data storage at intervals (see section 12.2 AUTOMATIC DATA STORAGE AT INTERVALS, page 112)

### 12.1 Manual storage

You can store a measurement dataset to the data storage as follows. At the same time, the dataset is output to the interface USB-B (*USB Device*, e.g. PC) or USB-A (*USB Host*, e.g. USB printer):

1. Press the **<STO>** key shortly.  
The menu for manual data storage appears.

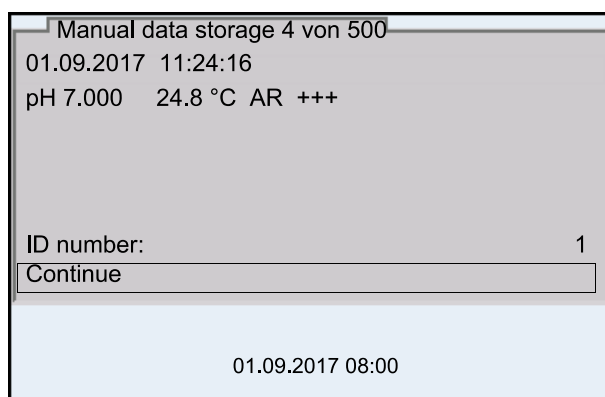

2. If necessary, change and confirm the ID number (1 ... 10000) with **<▲><▼>** and **<ENTER>**.  
The dataset is stored. The meter switches to the measured value display.

#### If the memory is full

When all storage locations are occupied, it is not possible to continue storing. Then you can e.g. transmit the stored data to a PC or a USB flash drive (see section 12.3.1 EDITING THE MEASUREMENT DATA STORAGE, page 115) and subsequently erase the storage (see section 12.3.2 ERASING THE MEASUREMENT DATA STORAGE, page 116).

### 12.2 Automatic data storage at intervals

The storing interval (*Interval*) determines the time interval between automatic data storing processes. With any storing process, the dataset is simultaneously output to the interface USB-B (*USB Device*, e.g. PC) or USB-A (*USB Host*, e.g. USB printer).

#### Configuring the automatic memory function

1. Press the **<STO\_>** key.  
The menu for automatic data storing appears.



Automatic data storage

ID number 1

Interval 30 s

Duration 180 min

Continue

0d03h00min

0 1d17h33min

01.09.2017 08:00

- 1 Specified entire storing duration
- 2 Max. available storing duration
- 3 Graphical display of the memory usage

**Settings** You can configure the automatic data storing function with the following settings:

Menu item	Possible setting	Explanation
<i>ID number</i>	1 ... 10000	ID number for the dataset series.
<i>Interval</i>	1 s, 5 s, 10 s, 30 s, 1 min, 5 min, 10 min, 15 min, 30 min, 60 min	Storing interval. The lower limit of the storing interval can be restricted by the number of free memory locations. The upper limit is restricted by the storing duration.
<i>Duration</i>	1 min ... x min	Storing duration. Specifies after which time the automatic data storing should be terminated. The lower limit of the storage duration is restricted by the storage interval. The upper limit is restricted by the number of free memory locations.

### Starting the automatic storing function

To start the automatic storing function, select *Continue* with  $\langle \blacktriangle \rangle \langle \blacktriangledown \rangle$  and confirm with  $\langle \text{ENTER} \rangle$ . The meter switches to the measured value display.

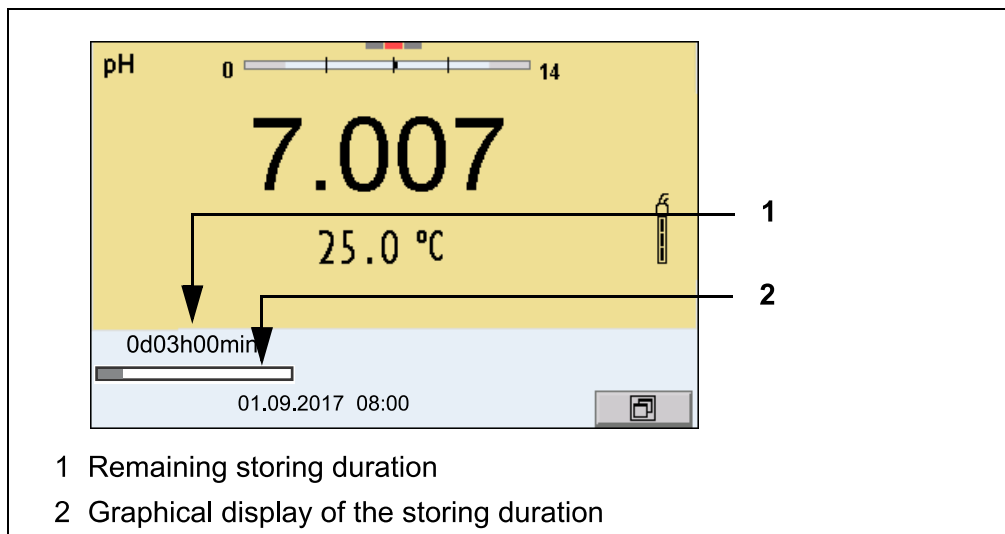

The active automatic data storing function can be recognized by the progress bar in the status line. The progress bar indicates the remaining storage duration.



If the automatic data storage function is activated, only the following keys are active:  $\langle \text{M} \rangle \langle \blacktriangle \rangle \langle \blacktriangledown \rangle \langle \text{STO}_\_ \rangle$  and  $\langle \text{On/Off} \rangle$ . The other keys and the automatic switch-off function are deactivated.

### Terminating the automatic memory function prematurely

Proceed as follows to switch off the automatic data storing function before the adjusted storing duration has expired:

1. Press the  $\langle \text{STO}_\_ \rangle$  key.  
The following window appears.

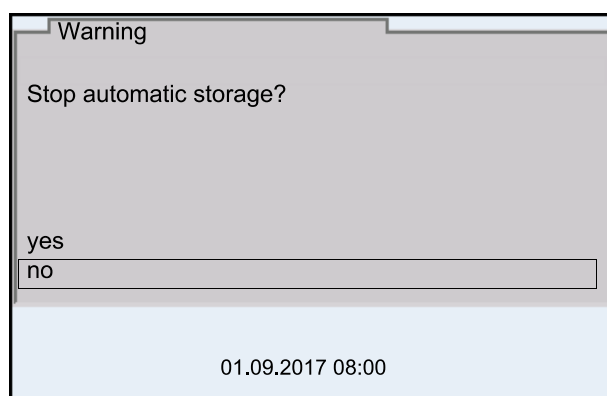

2. Using  $\langle \blacktriangle \rangle \langle \blacktriangledown \rangle$ , select *yes* and confirm with  $\langle \text{ENTER} \rangle$ .  
The meter switches to the measured value display.  
The automatic data storing function is terminated.

## 12.3 Measurement data storage

### 12.3.1 Editing the measurement data storage

The contents of the manual or automatic measurement data storage can be shown on the display.

Each of the measurement data memories has a function to erase the entire contents.

#### Editing the data storage

The memory is edited in the menu, *Storage & config/ Data storage*. To open the *Storage & config* menu, press the **<ENTER\_>** key in the measured value display.

Open the manual or automatic storage directly with the **<RCL>** or **<RCL\_>** key.



The settings are explained here using the manual data storage as an example. The same settings and functions are available for the automatic data storage and OUR/SOUR.

#### Settings

Menu item	Setting/ function	Explanation
<i>Data storage / Manual data storage / Display</i>	-	Displays all measurement datasets page by page.  Further options: <ul style="list-style-type: none"> <li>● Scroll through the datasets with <b>&lt;&lt;&gt;&gt;&lt;&gt;&gt;</b>.</li> <li>● Output the displayed dataset to the interface with <b>&lt;PRT&gt;</b>.</li> <li>● Quit the display with <b>&lt;ESC&gt;</b>.</li> </ul>
<i>Data storage / Manual data storage / Output to USB flash drive or printer</i>	-	Outputs all stored measured values to the USB-A interface ( <i>USB Host</i> , e.g. USB memory device/ USB printer)
<i>Data storage / Manual data storage / Output to RS232/USB</i>	-	Outputs all stored measurement data to the USB-B interface ( <i>USB Device</i> , e.g. PC)
<i>Data storage / Manual data storage / Erase</i>	-	Erases the entire manual measurement data storage. Note: All calibration data remain stored when this action is performed.

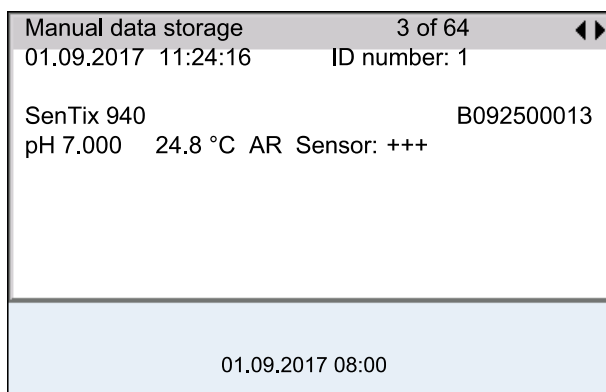
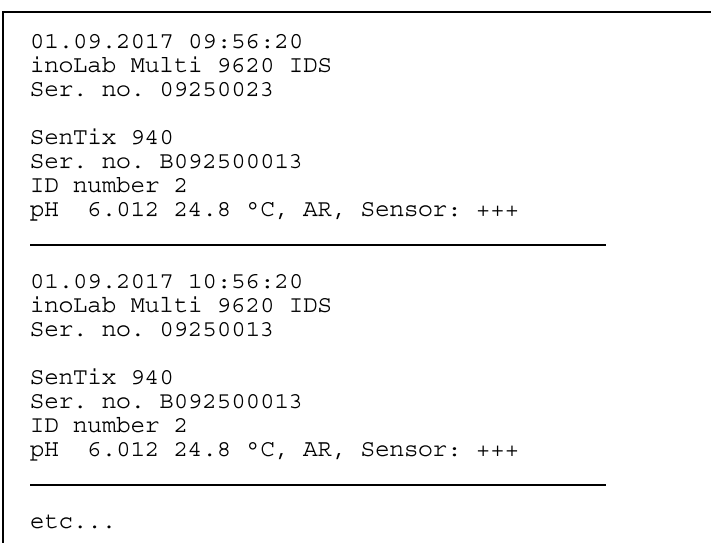
**Display presentation  
of a dataset****Sample printout****Quitting the display**

To quit the display of stored measurement datasets, you have the following options:

- Switch directly to the measured value display with **<M>**.
- Quit the display and move to the next higher menu level with **<ESC>**.

**12.3.2 Erasing the measurement data storage**

How to erase the measured value storage is described in section 12.3.1 EDITING THE MEASUREMENT DATA STORAGE, page 115.

**12.3.3 Measurement dataset**

A complete dataset consists of:

- Date/time
- Meter name, serial number
- Sensor name, serial number
- ID number

- Measured value of the connected sensor
- Measured temperature value of the connected sensor
- AutoRead info: *AR* appears with the measured value if the AutoRead criterion was met while storing (stable measured value). Otherwise, the *AR* display is missing.
- Calibration evaluation:
  - 4 levels (+++, ++, +, -, or no evaluation) or
  - QSC (percentage)

#### 12.3.4 Memory locations

The Multi 9620 IDS meter has two measurement data memories. The measured values recorded either manually or automatic are stored separately in individual measurement data memories.

<b>Data storage</b>	<b>Maximum number of datasets</b>
<i>Manual data storage</i>	500
<i>Automatic data storage</i>	10000

## 13 Transmitting data

The meter has the following interfaces:

- USB-B interface (*USB Device*)  
e.g. to connect a PC
- USB-A interface (*USB Host*),  
e.g. to connect a USB flash drive/USB printer

Via the USB-B interface (*USB Device*) you can transmit data to a PC or printer and update the meter software.

Via the USB-A interface (*USB Host*) it is possible to transfer data to an external USB memory device/USB printer.

### 13.1 Saving data to a USB memory device

Via the USB-A interface (*USB Host*) you can transmit data to a USB memory device or USB printer. How to transmit data to a USB printer is described in an extra section (see section 13.2 TRANSMITTING DATA TO A USB PRINTER, page 118).

#### Connecting the USB memory device

1. Connect a USB memory device to the USB-A interface (*USB Host*).

#### Transmitting data (options)

Data	Control	Operation / description
Stored measured values	Manual	All datasets with the function, <i>Output to USB flash drive or printer</i> (menu <i>Data storage / Manual data storage</i> or <i>Automatic data storage</i> ).  For details, see section 12.3.1 EDITING THE MEASUREMENT DATA STORAGE, page 115
Calibration data storage	Manual	All stored calibration records of a sensor with the function, <i>Output to USB flash drive or printer</i> (menu <i>Calibration / Calibration data storage</i> ). For details, see menu for calibration and measurement settings of the sensor.

### 13.2 Transmitting data to a USB printer

Via the USB-A interface (*USB Host*) you can transmit data to a USB printer or USB memory device. How to transmit data to a USB memory device is described in an extra section (see section 13.1 SAVING DATA TO A USB MEMORY DEVICE, page 118).

**Connecting a USB printer**

Suitable USB printers

Model	Type	Paper width
Citizen CT-S281	Thermal transfer printer	58 mm
Seiko Instruments Inc. DPU-S445*	Thermal transfer printer	58 mm
Star SP700 with USB interface**	Matrix printer	76 mm

\* Recommended printer settings for DPU-S445:

- Character Set : IBM Compatible

\*\* Recommended printer settings for Star SP700:

- CodePage 437

- DIP switch 1...7: =ON, DIP switch 8: OFF

Details: see operating manual of your printer.

1. Connect the USB printer to the *USB Host* interface.
2. Connect the power pack to the Multi 9620 IDS (see section 3.3.2 CONNECTING THE POWER PACK / CHARGING THE BATTERIES, page 13).  
As soon as the USB printer is identified by the meter, the printer status indicator [  ] is displayed.

**Transmitting data (options)**

The following table shows which data are transmitted to the interface in which way:

Data	Control	Operation / description
Current measured values of all connected sensors	Manual	<ul style="list-style-type: none"> <li>● With <b>&lt;PRT&gt;</b>.</li> <li>● Simultaneously with every manual storing process (see section 12.1 MANUAL STORAGE, page 112).</li> </ul>
	Automatic, at intervals	<ul style="list-style-type: none"> <li>● With <b>&lt;PRT_&gt;</b>. Then you can set the transmission interval</li> <li>● Simultaneously with every automatic storing process (see section 12.2 AUTOMATIC DATA STORAGE AT INTERVALS, page 112).</li> </ul>
Stored measured values	Manual	<ul style="list-style-type: none"> <li>● Displayed dataset with <b>&lt;PRT&gt;</b> after calling up from the storage.</li> <li>● All datasets with the function, <i>Output to USB flash drive or printer</i> (menu <i>Data storage / Manual data storage</i> or <i>Automatic data storage</i>).</li> </ul> <p>For details, see section 12.3.1 EDITING THE MEASUREMENT DATA STORAGE, page 115.</p>

Data	Control	Operation / description
Calibration records	Manual	<ul style="list-style-type: none"> <li>● Displayed calibration record with <b>&lt;PRT&gt;</b>.</li> <li>● All stored calibration records of a sensor with the function, <i>Output to USB flash drive or printer</i> (menu <i>Calibration / Calibration data storage</i>).</li> </ul> <p>For details, see menu for calibration and measurement settings of the sensor.</p>
	Automatic	<ul style="list-style-type: none"> <li>● At the end of a calibration procedure</li> </ul>



The following rule applies: With the exception of the menus, shortly pressing the **<PRT>** key generally outputs the display contents to the interface (displayed measured values, measuring datasets, calibration records). If there is a USB-B connection (*USB Device*), e.g. to a PC, the data are output to the USB-B interface only (*USB Device*).

### 13.3 Transmitting data to a PC

Via the USB-B interface (*USB Device*) you can transmit data to a PC.

#### PC system requirements

- Microsoft Windows (for details, see enclosed installation CD, *Driver* directory)
- Installed USB driver for the meter (see CD-ROM or Internet)
- Settings for the USB/RS232 interface on the PC and meter in agreement
- Program to receive the measurement data on the PC (e.g. MultiLab Importer, see CD-ROM or Internet)

#### Installation of the USB driver

1. Insert the supplied installation CD in the CD drive of your PC.  
or  
Download the USB driver from the Internet.
2. Install the driver.  
Follow the Windows installation instructions as necessary.

#### Connecting a PC

1. Connect the inoLab® Multi 9620 IDS to the PC via the USB-B interface (*USB Device*).  
The meter is listed as a virtual COM interface among the connections in the Windows instrument manager.



**Adjusting the settings for the data transmission**

2. Set the same transmission data at the meter and PC:
  - Baud rate: to be selected in the range 1200 ... 19200
  - Set at the PC only:
    - Handshake: RTS/CTS
    - Parity: none
    - Data bits: 8
    - Stop bits: 1

**Starting the program for the data reception**

3. On the PC, start the program for the data reception, e.g.:
  - MultiLab Importer (see section 13.4 MULTILAB IMPORTER, page 122)
  - Terminal program

**Transmitting data (options)**

Data	Control	Operation / description
Current measured values of all connected sensors	Manual	<ul style="list-style-type: none"> <li>● With <b>&lt;PRT&gt;</b>.</li> <li>● Simultaneously with every manual storing process (see section 12.1 MANUAL STORAGE, page 112).</li> </ul>
	Automatic, at intervals	<ul style="list-style-type: none"> <li>● With <b>&lt;PRT_&gt;</b>. Then you can set the transmission interval</li> <li>● Simultaneously with every automatic storing process (see section 12.2 AUTOMATIC DATA STORAGE AT INTERVALS, page 112).</li> </ul>
Stored measured values	Manual	<ul style="list-style-type: none"> <li>● Displayed dataset with <b>&lt;PRT&gt;</b> after calling up from the storage.</li> <li>● All datasets with the function, <i>Output to RS232/USB</i> (menu <i>Data storage / Manual data storage</i> or <i>Automatic data storage</i>). For details, see section 12.3.1 EDITING THE MEASUREMENT DATA STORAGE, page 115.</li> </ul>
Calibration records	Manual	<ul style="list-style-type: none"> <li>● Displayed calibration record with <b>&lt;PRT&gt;</b></li> <li>● All calibration records with <i>Output to RS232/USB</i> (menu <i>Calibration / Calibration data storage</i>)</li> </ul>
	Automatic	<ul style="list-style-type: none"> <li>● At the end of a calibration procedure</li> </ul>



The following rule applies: With the exception of the menus, shortly pressing the <PRT> key generally outputs the display contents to the interface (displayed measured values, measuring datasets, calibration records). If there is a USB-B connection (*USB Device*), e.g. to a PC, the data are output to the USB-B interface only (*USB Device*).

### 13.4 MultiLab Importer

With the aid of the MultiLab Importer software, you can record and evaluate measurement data with a PC.



More detailed information can be found in the MultiLab Importer operating manual.

## 14 Maintenance, cleaning, disposal

### 14.1 Maintenance

#### 14.1.1 General maintenance activities

The only maintenance activity required is exchanging the battery that buffers the system clock.



See the relevant operating manuals of the IDS sensors for instructions on maintenance.

#### 14.1.2 Exchanging the battery

The Multi 9620 IDS has a battery (CR2032 type) to buffer the system clock in case of a power failure.



To retain the current setting of the date and time during the battery exchange, supply the meter with power with the power pack while changing the battery.

To avoid that the system clock is reset in the case of a power failure, we recommend changing the battery before the end of its service life (the battery included in the scope of delivery after approx. 5 years).

1. Unscrew the screws (2) of the lid of the battery compartment with a screwdriver.

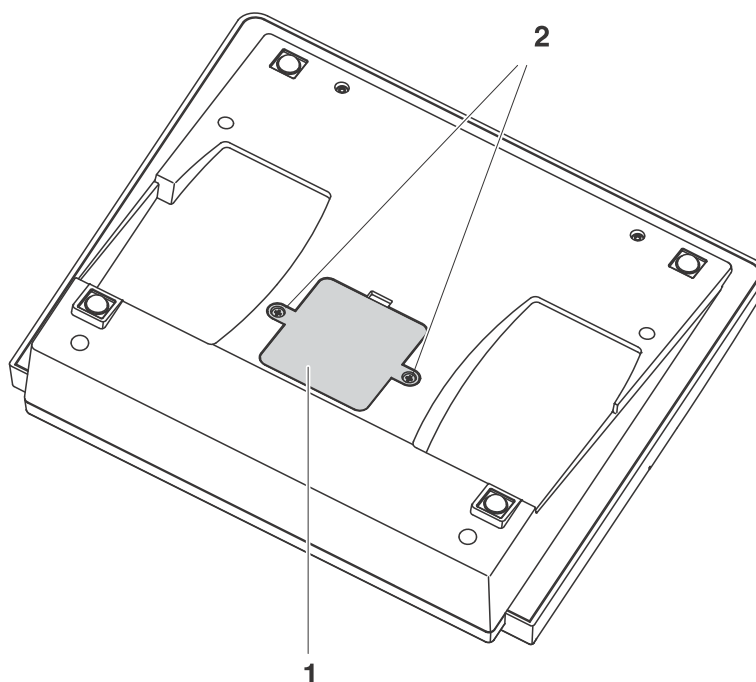

2. Open the battery compartment (1) on the underside of the meter.
3. Remove the battery from the battery compartment.
4. Insert a new battery in the battery compartment.
5. Close the battery compartment (1).
6. Tighten the screws (2) of the lid of the battery compartment with a screwdriver.
7. Set the date and time (see 4.5.5 EXAMPLE 2 ON NAVIGATION: SETTING THE DATE AND TIME, PAGE 25)



Dispose of used batteries according to the local regulations of your country.

End users within the European Union are obligated to return used batteries (even ecologically compatible ones) to a collection point set up for recycling purposes.

Batteries are marked with the crossed-out waste container symbol. Therefore, they may not be disposed with the domestic waste.

## 14.2 Cleaning

Occasionally wipe the outside of the measuring instrument with a damp, lint-free cloth. Disinfect the housing with isopropanol as required.



### **CAUTION**

**The housing is made of synthetic material (ABS). Thus, avoid contact with acetone or similar detergents that contain solvents. Remove any splashes immediately.**

## 14.3 Packing

This meter is sent out in a protective transport packing. We recommend: Keep the packing material. The original packing protects the meter against damage during transport.

## 14.4 Disposal

At the end of its operational lifetime, the meter must be returned to the disposal or return system statutory in your country. If you have any questions, please contact your supplier.

## 15 What to do if...

### 15.1 pH



More information and instructions on cleaning and exchange of sensors are given in the documentation of your sensor.

#### Error message *OFL, UFL*

Cause	Remedy
IDS pH sensor:	
– Measured value outside the measuring range	– Use suitable IDS pH sensor
– Air bubble in front of the junction	– Remove air bubble (e.g. sway or stir the solution)
– Air in the junction	– Extract air or moisten junction
– Cable broken	– Exchange IDS pH sensor
– Gel electrolyte dried out	– Exchange IDS pH sensor

#### Error message, *Error*

Cause	Remedy
IDS pH sensor:	
– The values determined for zero point and slope of the IDS pH sensor are outside the allowed limits.	– Recalibrate
– Junction contaminated	– Clean the junction
– IDS pH sensor broken	– Exchange IDS pH sensor
Buffer solutions:	
– The used buffer solutions do not agree with the set buffer set	– Set different buffer set or – Use different buffer solutions
– Buffer solutions too old	– Use only once. Note the shelf life
– Buffer solutions depleted	– Change solutions

No stable measured value	Cause	Remedy
	IDS pH sensor:	
	– Junction contaminated	– Clean the junction
	– Membrane contaminated	– Clean membrane
	Test sample:	
	– pH value not stable	– Measure with air excluded if necessary
	– Temperature not stable	– Adjust temperature if necessary
	IDS pH sensor + test sample:	
	– Conductivity too low	– Use suitable IDS pH sensor
	– Temperature too high	– Use suitable IDS pH sensor
	– Organic liquids	– Use suitable IDS pH sensor
Obviously incorrect measured values	Cause	Remedy
	IDS pH sensor:	
	– IDS pH sensor unsuitable	– Use suitable IDS sensor
	– Temperature difference between buffer and test sample too great	– Adjust temperature of buffer or sample solutions
	– Measurement procedure not suitable	– Follow special procedure

## 15.2 ISE

<b>Error message <i>OFL</i></b>	<b>Cause</b>	<b>Remedy</b>	
	– Measuring range exceeded	– Dilute test sample	
<b>Obviously incorrect measured values</b>	<b>Cause</b>	<b>Remedy</b>	
	– Electrode not connected	– Connect the electrode	
	– Cable broken	– Replace the electrode	
<b>Error message <i>Error</i> (Failed calibration) or Calibration evaluation <i>poor</i> (-)</b>	<b>Cause</b>	<b>Remedy</b>	
	<i>ISE electrode:</i>		
	– Moisture in the plug	– Dry plug	
	– Electrode obsolete	– Replace the electrode	
	– Electrode unsuitable for the range to be measured	– Use a suitable electrode	
	– Electrode not suitable for the selected ion	– Use a suitable electrode or select a suitable ion	
	– The gas-sensitive electrode NH 500 was calibrated with the <i>Ion type</i> NH4 setting	– Select the following settings: <i>Ion type</i> = ION, <i>Valency</i> = -1	
	– Socket damp	– Dry socket	
	<i>Calibration procedure:</i>		
	– Wrong sequence of standards for 3- to 7-point calibration	– Select correct sequence	
	– Calibration standards do not have the correct temperature (max. $\pm 2$ °C temperature difference)	– Adjust the temperature of the calibration standards	
	<b>Warning [<i>TpErr</i>]</b>	<b>Cause</b>	<b>Remedy</b>
		– Temperature difference between measurement and calibration greater than 2 °C.	– Adjust the temperature of the test sample
<b>Warning [<i>ISEErr</i>]</b>	<b>Cause</b>	<b>Remedy</b>	
	– Electrode voltage outside calibrated range	– Recalibrate	

### 15.3 Dissolved oxygen



More information and instructions on cleaning and exchange of sensors are given in the documentation of your sensor.

Error message, <i>OFL</i>	Cause	Remedy
	– Measured value outside the measuring range	– Select a suitable measuring medium

Error message, <i>Error</i>	Cause	Remedy
	– Sensor contaminated	– Clean the sensor
	– Measured temperature value outside the operating conditions (display of OFL/UFL instead of a temperature value)	– Keep to the temperature range for the test sample

	Cause	Remedy
	– Defective sensor	– Calibration – Exchange the sensor cap – Replace the sensor

### 15.4 Conductivity



More information and instructions on cleaning and exchange of sensors are given in the documentation of your sensor.

Error message, <i>OFL</i>	Cause	Remedy
	– Measured value outside the measuring range	– Use suitable IDS conductivity sensor

Error message, <i>Error</i>	Cause	Remedy
	– Sensor contaminated	– Clean the sensor and replace it if necessary
– Calibration solution not suitable	– Check the calibration solutions	



## 15.5 Turbidity

<b>Implausible turbidity values</b>	<b>Cause</b>	<b>Remedy</b>
	– There are gas bubbles (e.g. air bubbles) in front of the measurement window	– Remove the gas bubbles, e.g. by immersing the sensor at an angle
	– Incorrect calibration, e.g.: <ul style="list-style-type: none"> <li>– Unsuitable calibration standard solutions (e.g. too old)</li> <li>– Unsuitable calibration environment (e.g. gas bubbles, reflection, light)</li> </ul>	– Check the calibration
	– Minimum depth of immersion not observed	– Heed the minimum depth of immersion of the sensor (2 cm)
<b>Error message, OFL</b>	<b>Cause</b>	<b>Remedy</b>
	– Measured value outside the measuring range	– Select a suitable measuring medium
<b>Measured values too low</b>	<b>Cause</b>	<b>Remedy</b>
	– Measurement window soiled	– Clean the measurement window
<b>Measured values too high</b>	<b>Cause</b>	<b>Remedy</b>
	– Reflection at the walls or bottom of the measuring vessel	– Keep the minimum distance of the sensor towards the walls and bottom of the measuring vessel (see section 15.5 TURBIDITY, page 129)
	– Incidence of light	– Use a light-proof measuring vessel



More information and instructions on cleaning and exchange of sensors are given in the documentation of your sensor.

## 15.6 General topics

<b>Sensor symbol flashes</b>	<b>Cause</b> <ul style="list-style-type: none"> <li>– Calibration interval expired</li> </ul>	<b>Remedy</b> <ul style="list-style-type: none"> <li>– Recalibrate the measuring system</li> </ul>
<b>Meter does not react to keystroke</b>	<b>Cause</b> <ul style="list-style-type: none"> <li>– Operating condition undefined or EMC load unallowed</li> </ul>	<b>Remedy</b> <ul style="list-style-type: none"> <li>– Processor reset: Press the <b>&lt;ENTER&gt;</b> and <b>&lt;On/Off&gt;</b> key simultaneously</li> </ul>
<b>You want to know which software version is in the meter or IDS sensor</b>	<b>Cause</b> <ul style="list-style-type: none"> <li>– E.g., a question by the service department</li> </ul>	<b>Remedy</b> <ul style="list-style-type: none"> <li>– Switch on the meter.</li> <li>– Open the menu, <b>&lt;ENTER_&gt;</b> / <i>Storage &amp; config / System / Service information</i>. The instrument data are displayed.</li> </ul> <p>or</p> <ul style="list-style-type: none"> <li>– Connect the sensor. Press softkey <i>[Info]/[More]</i> The sensor data are displayed (see section 4.1.6 SENSOR INFO, page 17)</li> </ul>
<b>Data transmission to USB memory device does not work</b>	<b>Cause</b> <ul style="list-style-type: none"> <li>– Connected USB memory device was not recognized</li> <li>– The USB-B interface is connected to a PC</li> <li>– The USB memory device has been formatted to a file system which is not supported, e. g. NTFS</li> </ul>	<b>Remedy</b> <ul style="list-style-type: none"> <li>– Use other USB memory device</li> <li>– Disconnect the PC from the USB-B interface</li> <li>– Reformat the USB memory device to FAT 16 or FAT 32 file system (<u>Caution</u>: Reformatting erases all data on the USB memory device. Back up all data before reformatting.)</li> </ul>

<b>Data transmission to USB printer does not work</b>	<b>Cause</b> <ul style="list-style-type: none"> <li>– The USB-B interface is connected to a PC</li> <li>– Connected USB printer was not recognized</li> </ul>	<b>Remedy</b> <ul style="list-style-type: none"> <li>– Disconnect the PC from the USB-B interface</li> <li>– Use suitable USB printer (see section 13.2 TRANSMITTING DATA TO A USB PRINTER, page 118)</li> <li>– Check the printer settings (see section 13.2 TRANSMITTING DATA TO A USB PRINTER, page 118)</li> </ul>
<b>Error message, <i>Memory error 1</i></b>	<b>Cause</b> <ul style="list-style-type: none"> <li>– Instrument storage was not found</li> </ul>	<b>Remedy</b> <ul style="list-style-type: none"> <li>– <i>Please contact the service.</i></li> </ul>
<b>Time gets lost</b>	<b>Cause</b> <ul style="list-style-type: none"> <li>– Buffer battery is empty</li> </ul>	<b>Remedy</b> <ul style="list-style-type: none"> <li>– Change the buffer battery (see section 14.1.1 GENERAL MAINTENANCE ACTIVITIES, page 123)</li> </ul>

## 16 Technical data

### 16.1 Measuring ranges, resolution, accuracy

Measuring ranges, accuracy

Variable	Measuring range	Accuracy
Air pressure (absolute)*	300 ... 1100 mbar	± 4 mbar

\*Available only if a D.O. sensor is connected



Further data are given in the documentation of your sensor.

### 16.2 General data

Dimensions	Approx. 285 x 255 x 80 mm	
Weight	Approx. 2.5 kg (5.51 pounds)	
Mechanical structure	Type of protection	IP 43
Electrical safety	Protective class	III
Test certificates	CE	
Ambient conditions	Storage	- 25 °C ... + 65 °C
	Operation	0 °C ... + 40 °C
	Admissible relative humidity	Yearly mean: < 75 % 30 days/year: 95 % Other days: 85 %
Power supply	Power pack	Helmsman Industrial Co Ltd SEI0901100P Input: 100 ... 240 V ~ / 50 ... 60 Hz / 0.5 A Output: 9 Vdc, 1100 mA Primary plugs included in the scope of delivery: Euro, US, UK and Australian.
	Battery (to buffer the system clock in the case of a power failure)	Lithium button cell battery CR 2032, 3 V
USB interface ( <i>USB Device</i> )	Type	USB 1.1 USB-B ( <i>USB Device</i> ), PC
	Baud rate	Adjustable: 1200, 2400, 4800, 9600, 19200 Baud
	Data bits	8
	Stop bits	2
	Parity	None

	Handshake	RTS/CTS
	Cable length	Max. 3 m
USB interface ( <i>USB Host</i> )	Type	USB 2.0 USB-A ( <i>USB Host</i> ), USB device
Guidelines and norms used	EMC	EC directive 2014/30/EC EN 61326-1 EN 61000-3-2 EN 61000-3-3 FCC Class A
	Meter safety	EC directive 2014/35/EC EN 61010-1
	IP protection class	EN 60529

Keypad (antibacterial)

*Client:* **Autotype International Limited**  
**Grove Road**  
**Wantage**  
**Oxon**  
**OX12 7B2**  
**United Kingdom**

*Job Ref:* **04I0712**  
*Sample Ref No.:* **LSN 25/71815**  
*Date Received:* **15/07/2004**  
*Date Reported:* **03/03/2005**

## CERTIFICATE OF ANALYSIS

### AUTOTEX AM

*Meth. Desc*

**FILM TEST**

*Supplier:*

**AUTOTYPE**

Test	Result	Unit	Est
Salmonella enteritidis	99.6	%	Reduction After 24 Hours
Klebsiella pneumoniae	99.4	%	Reduction After 24 Hours
Pseudomonas aeruginosa	99.1	%	Reduction After 24 Hours
Streptococcus faecalis	99.4	%	Reduction After 24 Hours
Phoma violacea	99.0	%	Reduction After 48 Hours
Penicillium purpurogenum	99.3	%	Reduction After 48 Hours
Bacillus cereus	99.3	%	Reduction After 24 Hours
Saccharmyces cerevisiae	99.3	%	Reduction After 24 Hours

*Comment:* **The microbiological results demonstrate that the material under test exhibits biocidal activity.**



**R.P.Elliott**  
 CChem, MRSC, MIFST  
*Deputy Managing Director*

**C.Fuller**  
 BSc. (Hons.), CBiol., MBiol., MIFST  
*Company Microbiologist*

**J.Lloyd**  
 BSc. (Hons.)  
*Principal Microbiologist*

**P.M.Sutton**  
 CChem., MRSC.  
*Nutritional Services Manager*

**J.Elliott**  
 BSc. (Hons.), CBiol., MBiol  
*Senior Microbiologist*



**J. Francis**  
 BSc. (Hons.)  
*Senior Microbiologist*

**N.Stanton**  
 BSc. (Hons.)  
*Senior Microbiologist*

**Law Laboratories Ltd** Shady Lane, Great Barr, Birmingham B44 9ET England

04I0712/6/1/.

*Client:* **Autotype International Limited**  
**Grove Road**  
**Wantage**  
**Oxon**  
**OX12 7B2**  
**United Kingdom**

*Job Ref:* **05B1760**  
*Sample Ref No.:* **LSN 26/38123**  
*Date Received:* **24/10/2004**  
*Date Reported:* **21/02/2005**

## CERTIFICATE OF ANALYSIS

AUTOTEX AM AGED 15 YEARS

*Meth. Desc*

**Harmonised JIS Z2801/AATCC 100**

Test	Result	Unit	Est
Staphylococcus aureus	99.0	%	Reduction After 24 Hours
Escherichia coli 0157	99.8	%	Reduction After 24 Hours
Aspergillus niger	99.1	%	Reduction After 48 Hours

*Comment:* **The microbiological results demonstrate that the material under test exhibits biocidal activity against the above listed microbial strains.**



**R.P.Elliott**  
 CChem, MRSC, MIFST  
 Deputy Managing  
 Director

**C.Fuller**  
 BSc. (Hons.), CBiol., MBiol.,  
 MIFST  
 Company Microbiologist

**J.Lloyd**  
 BSc. (Hons.)  
 Principal  
 Microbiologist

**P.M.Sutton**  
 CChem., MRSC.  
 Nutritional Services  
 Manager

**J.Elliott**  
 BSc. (Hons.), CBiol., MBiol  
 Senior  
 Microbiologist



**J. Francis**  
 BSc. (Hons.)  
 Senior Microbiologist

**N.Stanton**  
 BSc. (Hons.)  
 Senior  
 Microbiologist

**Law Laboratories Ltd** Shady Lane, Great Barr, Birmingham B44 9ET England

05B1760/1/3/.

## 17 Firmware update

### 17.1 Firmware update for the meter Multi 9620 IDS

You can find available firmware update files for your meter on the Internet. With the "Firmware Update " program and a PC you can update the firmware of the Multi 9620 IDS to the newest version.

For the update you have to connect the meter to a PC.

For the update via the USB-B interface, the following is required:

- a free USB interface (virtual COM port) on the PC
- the driver for the USB interface (on the enclosed CD-ROM)
- the USB cable (included in the scope of delivery of the Multi 9620 IDS).

1. Install the downloaded firmware update on a PC.  
An update folder is created in the Windows start menu.  
If an update folder already exists for the meter (or meter type), the new data are displayed there.
2. In the windows start menu, open the update folder and start the firmware update program for the meter
3. Using the USB interface cable, connect the Multi 9620 IDS to a USB interface (virtual COM port) of the PC.
4. Switch on the Multi 9620 IDS.
5. In the firmware update program, start the update process with OK.
6. Follow the instructions of the firmware update program.  
During the programming process, a corresponding message and a progress bar (in %) are displayed.  
The programming process takes up to 20 minutes. A terminatory message is displayed after a successful programming process. The firmware update is completed.
7. Disconnect the Multi 9620 IDS from the PC.  
The Multi 9620 IDS is ready for operation again.

After switching the meter off and on you can check whether the meter has taken over the new software version (see YOU WANT TO KNOW WHICH SOFTWARE VERSION IS IN THE METER OR IDS SENSOR, PAGE 130).



## 17.2 Firmware-Update for IDS Sensors

With the "Firmware Update" program and a PC you can update the firmware of an IDS sensor to the newest version.

You can find available firmware update files for your IDS sensor on the Internet.

For updating, connect the IDS sensor to the Multi 9620 IDS, and the Multi 9620 IDS to a PC.

For the update via the USB-B interface, the following is required:

- a free USB interface (virtual COM port) on the PC
- the driver for the USB interface (on the enclosed CD-ROM)
- the USB cable (included in the scope of delivery of the Multi 9620 IDS).

1. Install the downloaded firmware update on a PC.  
An update folder is created in the Windows start menu.  
If an update folder already exists for the sensor (or sensor type), the new data are displayed there.
2. In the windows start menu, open the update folder and start the firmware update program for the IDS sensor
3. Connect the IDS sensor to the Multi 9620 IDS meter.  
Only the sensor connection in the lower section of the socket field (channel 1) is suitable for the firmware update.
4. Using the USB interface cable, connect the Multi 9620 IDS to a USB interface (virtual COM port) of the PC.
5. Switch on the Multi 9620 IDS.
6. In the firmware update program, start the update process with OK.
7. Follow the instructions of the firmware update program.  
During the programming process, a corresponding message and a progress bar (in %) are displayed.  
The programming process takes up to 5 minutes. A terminatory message is displayed after a successful programming process. The firmware update is completed.
8. Disconnect the Multi 9620 IDS from the PC.  
Meter and sensor are ready for operation again.

After switching the meter off and on you can check whether the sensor has taken over the new software version (see YOU WANT TO KNOW WHICH SOFTWARE VERSION IS IN THE METER OR IDS SENSOR, PAGE 130).

## 18 Glossary

### pH/ORP/ISE

<b>Asymmetry</b>	see zero point
<b>Junction</b>	The junction is a porous body in the housing wall of reference electrodes or electrolyte bridges. It arranges the electrical contact between two solutions and makes the electrolyte exchange more difficult. The expression, junction, is also used for ground or junction-less transitions.
<b>Electromotive force of an electrode</b>	The electromotive force $U$ of the electrode is the measurable electromotive force of an electrode in a solution. It equals the sum of all the galvanic voltages of the electrode. Its dependency on the pH results in the electrode function, which is characterized by the parameters, slope and zero point.
<b>Zero point</b>	The zero point of a pH electrode is the pH value at which the electromotive force of the pH electrode at a specified temperature is zero. Normally, this is at 25 °C.
<b>pH value</b>	The pH value is a measure of the acidic or basic effect of an aqueous solution. It corresponds to the negative decadic logarithm of the molal hydrogen ions activity divided by the unit of the molality. The practical pH value is the value of a pH measurement.
<b>Potentiometry</b>	Name of a measuring technique. The signal (depending on the measured parameter) of the electrode is the electrical potential. The electrical current remains constant.
<b>ORP (U)</b>	The ORP is caused by oxidizing or reducing substances dissolved in water if these substances become effective on an electrode surface (e.g. a gold or platinum surface).
<b>Slope</b>	The slope of a linear calibration function.

### Conductivity

<b>Conductivity (<math>\chi</math>)</b>	Short form of the expression, specific electrical conductivity. It corresponds to the reciprocal value of the resistivity. It is a measured value of the ability of a substance to conduct an electric current. In water analysis, the electrical conductivity is a dimension for the ionized substances in a solution.
<b>Reference temperature</b>	Fixed temperature value to compare temperature-dependent measured values. For conductivity measurements, the measured value is converted to a conductivity value at a reference temperature of 20 °C or 25 °C.
<b>Salinity</b>	The absolute salinity $S_A$ of seawater corresponds to the relationship of the mass of dissolved salts to the mass of the solution (in g/Kg). In practice, this dimension cannot be measured directly. Therefore, the practical salinity according to IOT is used for oceanographic monitoring. It is determined by measuring the electrical conductivity.

<b>Salt content</b>	General designation for the quantity of salt dissolved in water.
<b>Temperature coefficient</b>	Value of the slope $\alpha$ of a linear temperature function. $\mathcal{R}_{T_{\text{Ref}}} = \mathcal{R}_{\text{Meas}} * \frac{1}{1 + \alpha * (T - T_{\text{Ref}})}$
<b>Temperature compensation</b>	Name of a function that considers the temperature influence on the measurement and converts it accordingly. Depending on the measured parameter to be determined, the temperature compensation functions in different ways. For conductimetric measurements, the measured value is converted to a defined reference temperature. For potentiometric measurements, the slope value is adjusted to the temperature of the test sample but the measured value is not converted.
<b>Resistivity (<math>\rho</math>)</b>	Short name for the specific electrolytic resistance. It corresponds to the reciprocal value of the electrical conductivity.
<b>Cell constant (c)</b>	Characteristic quantity of a conductivity measuring cell, depending on the geometry.

### Dissolved oxygen

<b>OxiCal®</b>	WTW name for a procedure to calibrate D.O. measuring systems in water vapor saturated air.
<b>Salinity</b>	The absolute salinity $S_A$ of seawater corresponds to the relationship of the mass of dissolved salts to the mass of the solution (in g/Kg). In practice, this dimension cannot be measured directly. Therefore, the practical salinity according to IOT is used for oceanographic monitoring. It is determined by measuring the electrical conductivity.
<b>Salt content</b>	General designation for the quantity of salt dissolved in water.
<b>?DO partial pressure</b>	Pressure caused by the oxygen in a gas mixture or liquid.
<b>D.O. saturation</b>	Short name for the relative D.O. saturation.
<b>Slope (relative)</b>	Designation used by WTW in the D.O. measuring technique. It expresses the relation of the slope value to the value of a theoretical reference sensor of the same construction type.

### General topics

<b>Resolution</b>	Smallest difference between two measured values that can be displayed by a meter.
<b>AutoRange</b>	Name of the automatic selection of the measuring range.
<b>Adjusting</b>	To manipulate a measuring system so that the relevant value (e.g. the displayed value) differs as little as possible from the correct value or a value that is regarded as correct, or that the difference remains within the tolerance.

---

<b>Calibration</b>	Comparing the value from a measuring system (e.g. the displayed value) to the correct value or a value that is regarded as correct. Often, this expression is also used when the measuring system is adjusted at the same time (see adjusting).
<b>Measured parameter</b>	The measured parameter is the physical dimension determined by measuring, e.g. pH, conductivity or D.O. concentration.
<b>Test sample</b>	Designation of the test sample ready to be measured. Normally, a test sample is made by processing the original sample. The test sample and original sample are identical if the test sample was not processed.
<b>Measured value</b>	The measured value is the special value of a measured parameter to be determined. It is given as a combination of the numerical value and unit (e.g. 3 m; 0.5 s; 5.2 A; 373.15 K).
<b>Molality</b>	Molality is the quantity (in Mol) of a dissolved substance in 1000 g solvent.
<b>Reset</b>	Restoring the original condition of all settings of a measuring system.
<b>Stability control (AutoRead)</b>	Function to control the measured value stability.
<b>Standard solution</b>	The standard solution is a solution where the measured value is known by definition. It is used to calibrate a measuring system.
<b>Temperature function</b>	Name of a mathematical function expressing the temperature behavior of a test sample, a sensor or part of a sensor.

## 19 Index

### A

AutoRead .....	71, 80, 87
ORP .....	43, 45
pH .....	27, 48

### B

Battery compartment .....	124
Blank value addition .....	67

### C

Calibration	
Conductivity .....	83
ISE .....	50
pH .....	29, 46
Calibration evaluation	
Conductivity .....	85
ISE .....	54, 91
O <sub>2</sub> .....	78
pH .....	37
Calibration interval	
Conductivity .....	103, 105
O <sub>2</sub> .....	101
pH .....	97
Calibration points	
pH .....	35
Calibration records .....	84
Cell constant .....	83
Comparison measurement (D.O.) .....	75
Connect the power pack .....	13
Connecting a PC .....	118, 120
Connectors .....	16
Copyright .....	2

### D

Dataset .....	116
Date and time .....	25
Default settings	
Measured parameter .....	108
System settings .....	111
Display .....	15

### F

FDO® Check .....	73
Firmware update .....	136

### I

Initial commissioning .....	12
Initialize .....	108
Interval for calibration .....	97

### K

Keys .....	14
------------	----

### M

Measured value display .....	21
Measurement accuracy .....	97
Measurement data memory	
Edit .....	115
Erase .....	115
Memory locations .....	117
Measurement dataset .....	116
Measuring	
Conductivity .....	80, 86
ISE .....	47
O <sub>2</sub> .....	70
ORP .....	43, 44
pH .....	27
Measuring method .....	56
Blank value addition .....	67
Sample addition .....	62
Sample subtraction .....	64
Standard addition .....	57
Standard subtraction .....	59
Menu for calibration and measurement settings	
pH/ORP .....	98
Menus (navigation) .....	21
Messages .....	23

### P

pH buffer sets .....	95
----------------------	----

### R

Reset .....	108
-------------	-----

### S

Safety .....	10
Sample addition .....	62
Sample subtraction .....	64
Scope of delivery .....	12
Single-point calibration	
pH .....	30, 34
Slope	
ISE .....	50
pH .....	29
Slope, relative .....	75
Stability control	
Automatic .....	107
Manual .....	27, 43, 71
Standard addition .....	57

---

Standard addition with blank value correction	
67	
Standard subtraction .....	59
Storing in memory .....	112
Automatic .....	112
Manual .....	112
Storing interval .....	112
<b>T</b>	
Temperature compensation .....	82
Temperature measurement	
Conductivity .....	82
ISE .....	49
O2 .....	72
pH .....	28, 46
Three-point calibration	
ISE .....	52, 91
pH .....	31, 35
Transmitting data .....	118
Transmitting measured values .....	118
Two-point calibration	
ISE .....	51, 90
pH .....	30, 34
<b>Z</b>	
Zero point of pH electrode .....	29



# What can Xylem do for you?

We're a global team unified in a common purpose: creating innovative solutions to meet our world's water needs. Developing new technologies that will improve the way water is used, conserved, and re-used in the future is central to our work. We move, treat, analyze, and return water to the environment, and we help people use water efficiently, in their homes, buildings, factories and farms. In more than 150 countries, we have strong, long-standing relationships with customers who know us for our powerful combination of leading product brands and applications expertise, backed by a legacy of innovation.

**For more information on how Xylem can help you, go to [xylem.com](http://xylem.com).**



**Service address:**

Xylem Analytics Germany  
Sales GmbH & Co. KG  
WTW  
Dr.-Karl-Slevogt-Str. 1  
82362 Weilheim  
Germany

Tel.: +49 881 183-325  
Fax: +49 881 183-414  
E-Mail [wtw.rma@xylem.com](mailto:wtw.rma@xylem.com)  
Internet: [www.WTW.com](http://www.WTW.com)



Xylem Analytics Germany GmbH  
Dr.-Karl-Slevogt-Str. 1  
82362 Weilheim  
Germany